



Manfrotto Video Supports

 **Manfrotto**
Imagine More

manfrotto.com



Manfrotto Video Supports



Technological evolution is profoundly changing videography. Camcorder performance improves, even as camcorders themselves shrink in size and become more affordable; meanwhile, the latest HD/SLRs combine top quality video with proven photographic capabilities. As a result, more and more new users are picking up cameras, joining our world and producing fantastic results.

HD/SLR cameras and the latest interchangeable lens camcorders make new demands of support and accessory equipment too, demands answered by Manfrotto Video Products. Manfrotto offer both traditional support systems and innovative alternative supports for video, all backed up by a complete range of accessories ranging from video camera and HD/SLR remote controls to bags and carrying solutions.

This is an exciting time for us at Manfrotto: the increasing fusion of video and photo equipment and the crossover of users between the two worlds let us apply even more of our photographic sector experience, knowledge and leadership to videography. Collaborating with some of the greatest names in film and video, we're developing the well-designed, high performance, top quality, innovative products that meet and exceed the expectations of our demanding expert users... and help set the pace of the evolution of technology.

We hope you'll find the catalogue inspiring and useful. For all the news that's still too new to print, please visit www.manfrotto.com

Contents	4	HEADS
	18	TRIPODS
	28	MONOPODS
	30	SYMPLA FIG RIG SYSTEM
	44	FIG RIG
	46	REMOTE CONTROLS
	54	ALTERNATIVE SUPPORTS
	56	ACCESSORIES
	62	BAGS AND STRAPS
	66	INDEX

To understand the icons, consult the key to symbols on the back page.





HEADS

BRIDGING TECHNOLOGY™

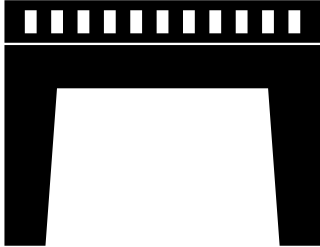

Video technology has changed radically in recent years, with a quick succession of ever lighter, more compact cameras launched. These cameras have in turn led to new ways of filming, allowing one-man units to produce results that only a few short years ago would have required a full crew.

Video is moving to a new dimension, Bridging Technology™ heads help you cross over!

The Bridging Technology™ range is a key element in Manfrotto's response to these changes in the video sector. The ergonomic and technical characteristics of our Bridging Technology™ series are the result of our expertise in producing lightweight camera supports. The extended range offers ideal support across the full spectrum of "new" video cameras, providing a perfect match for the latest camcorders, HD SLRs and even 3D rigs, with each individual head designed and engineered to help videographers get the best possible results from HD camera equipment.



Bridging Technology™: an exclusive Manfrotto patent.

The perfect synthesis of an innovative “bridge” structure and cutting-edge engineering.

Real fluid cartridges, longer sliding plates and inner ball-bearings ensure that all our Bridging Technology™ heads provide smoother shooting, better balance and more precise movement.

Suitable for a wide range of cameras, Bridging Technology™ heads have maximum loads between 5kg and 12kg, and are also available in combination with a variety of aluminum or carbon fiber twin- or single-tube tripods.





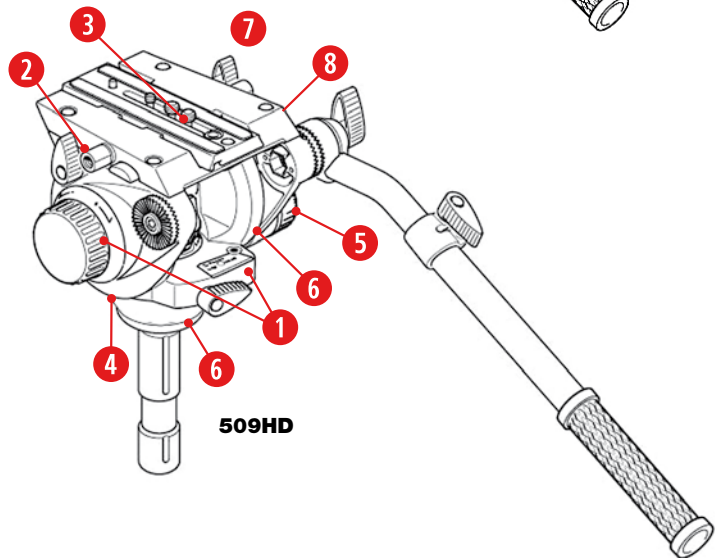
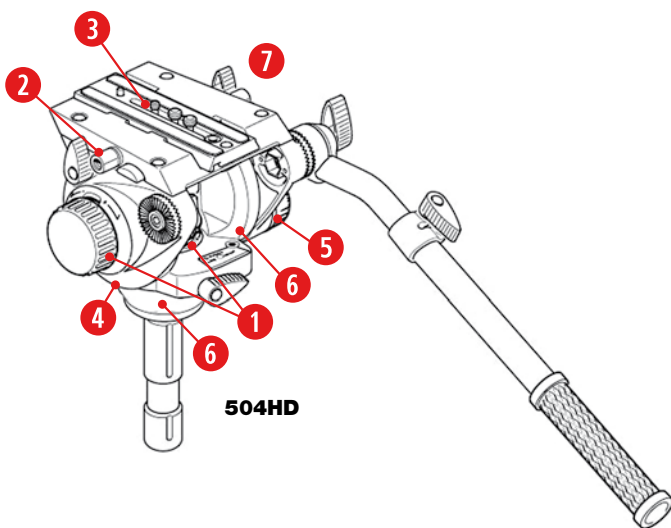
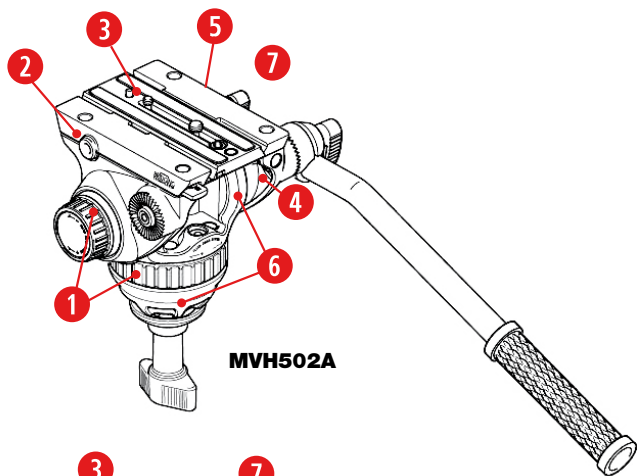
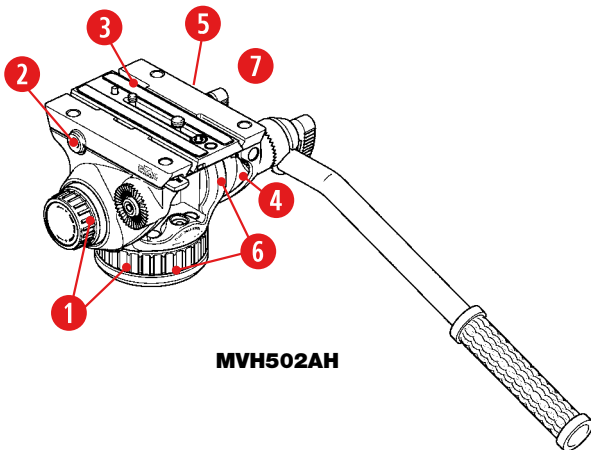
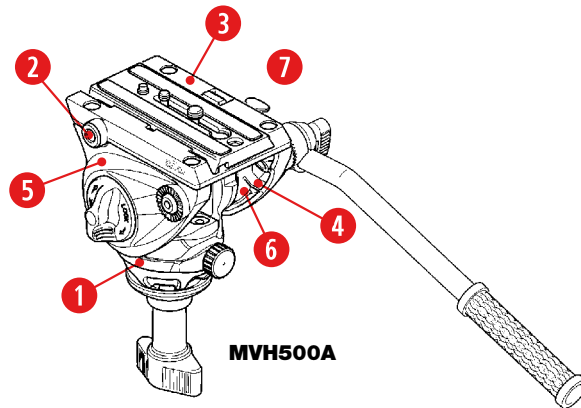
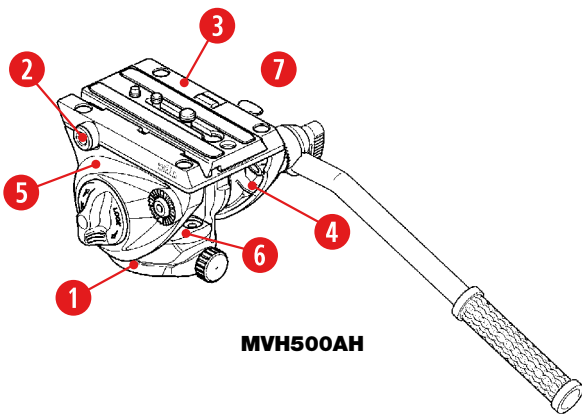



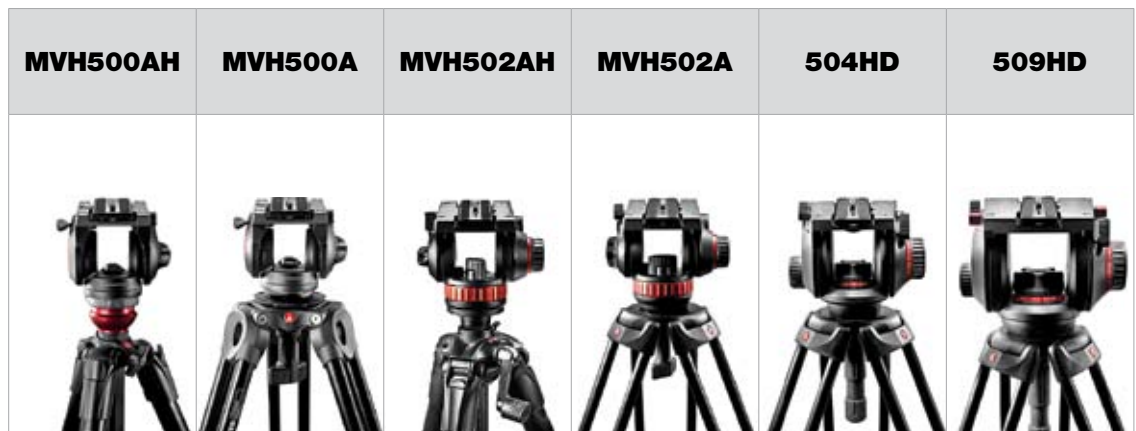



Unique features for unique footage



- 1 Fluid cartridges for smooth movement and precise control
- 2 3/8" Easy Link connector to support external accessories
- 3 Wider platform for HD/SLR bodies and the sliding plate travel to balance the latest cameras with interchangeable lenses
- 4 An even more rigid structure for maximum precision and improved responsiveness
- 5 Counterbalance system ensures quick set-up and optimal performance
- 6 Ball bearings for more precise, smooth movements
- 7 Lightweight modern materials for optimum balance of strength and size
- 8 ABR (Advanced Balancing Recorder) for precision when fixing equipment, ensuring a perfect position, saving time and making this operation much more efficient, accurate and fast



		MVH500AH	MVH500A	MVH502AH	MVH502A	504HD	509HD
	Fluidity PAN & TILT	Fixed Cartridges	Fixed Cartridges	Variable Fluid Cartridges	Variable Fluid Cartridges	Variable Fluid Cartridges	Variable Fluid Cartridges
	Counter-balance System	Fixed	Fixed	Fixed	Fixed	4 steps	4 steps
	Flat base	Flat base with 3/8" female attachment		Flat base with 3/8" female attachment			
	Leveling bowl		Ø 60mm		Ø 75mm	Ø 75mm	Ø 100mm
	ABR (Advanced Balancing Recorder)	N.A.	N.A.	N.A.	N.A.	N.A.	Available
	Counter-balance weight	2,4kg - 5.3lb	2,4kg - 5.3lb	4kg - 8.8lb	4kg - 8.8lb	7,5kg - 16.5lb	8,5kg - 18.7lb
	Safety payload	5kg - 11lb	5kg - 11lb	7kg - 15.4lb	7kg - 15.4lb	12kg - 26.5lb	9kg - 19.8lb
	Center of gravity	55	55	55	55	55	125
	Weight	0,9kg - 2.1lb	1,1kg - 2.5lb	1,6kg - 3.6lb	1,8kg - 4lb	2,9kg - 6.4lb	3,9kg - 8.6lb
	Head height	9,5cm - 3.7in	12,6cm - 5in	13cm - 5.1in	15cm - 5.9in	15,5cm - 6in	18cm - 7in
	Sliding plate	500PLONG	500PLONG	504PLONG	504PLONG	504PLONG	509PLONG
		(120mm - 4.7in)	(140mm - 5.5in)	(140mm - 5.5in)	(140mm - 5.5in)	(140mm - 5.5in)	(140mm - 5.5in)
	Easy Link connectors	Available x 1	Available x 1	Available x 2	Available x 2	Available x 2	Available x 2
	Leveling bubble	Available	Available	Available	Available	Available (illuminated)	Available (illuminated)



MVH500A

MVH500AH



MVH500A FLUID VIDEO HEAD - 60MM HALF BALL

The new 500, which replaces the 701HDV, is a lightweight video head featuring a wider platform to accommodate both HD/SLR and interchangeable lens camcorder, as well as a sliding plate that ensures the appropriate balance even when shooting with very long lenses. The 500, the entry level of the Bridging Technology™ series, ensures smooth shots and fine control of up to 5kg of equipment. Its brand new side lock allows fast, secure and easy camera attachment. It has one Easy Link 3/8" connector to allow an external monitor or other accessory equipment to be fitted. The MVH500A has a 60mm half ball video tripod mount.

2,4kg 5.3lb	5kg 11lb	12,6cm 4,9in	1,1kg 2.5lb	500PLONG

MVH500AH FLUID VIDEO HEAD - FLAT BASE

Same characteristics as the MVH500A, but with a flat base mount with standard 3/8" thread. Ideal for tripod/slider/rig/crane application.

2,4kg 5.3lb	5kg 11lb	9,5cm 3.7in-	0,9kg 2.1lb	500PLONG

COUNTERBALANCE GRAPH

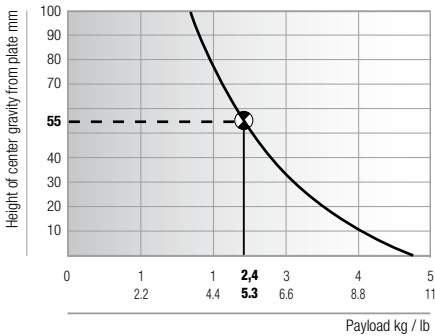

- 1 Locking knobs
- 2 CBS: Counterbalance System
- 3 Leveling bubble



- 1 FDS: Fluid Drag System
- 2 Locking knobs
- 3 Wider platform + longer sliding plate
- 4 Easy Link - 3/8" thread connection



- 1 FDS: Fluid Drag System
- 2 Side lock lever



TECHNICAL SPECIFICATIONS

Head base	60mm half ball (MVH500A) - Flat (MVH500AH)
Pan drag type	Fixed fluid cartridge
Tilt drag type	Fixed fluid cartridge
Counterbalance weight	Fixed @ 2,4kg (5.3lb)
Safety payload	5kg (11lb)
Leveling bubble	Available
Pan bar	Available

Pan bar attachment	Available on right and left sides
Replaceable pan bar rosette	No
Plate type	500PLONG Quick Release with Side Lock
Plate travel	100mm (39in)
Plate attachment	3/8" and 1/4" camera screws + anti-rotation pin
Pan range	360°
Tilt range	-70° +90°
Temperature range	-20° C +60° C



MVM500A
FLUID MONOPOD WITH 500 HEAD

- 2.4kg
5.3lb
- 5kg
11lb
- 77cm
30in
- 200,5cm
78.2in
- 2.1kg
4.7lb
- 500PLONG



MVK500AM SYSTEM

- 2.4kg
5.3lb
- 5kg
11lb
- 72cm
28.3in
- 67,5cm
26.3in
- 154cm
60.1in
- 3,1kg
6.8lb

Head MVH500A
Tripod Aluminum MVT502AM
Mid spreader included
Bag included



MVK500C SYSTEM

- 2.4kg
5.3lb
- 5kg
11lb
- 85cm
33.4in
- 38,5cm
15in
- 182,5cm
71.2in
- 3,4kg
7.5lb

Head MVH500A
Tripod Carbon Fiber 535
Bag included



MVH500AH, 755CX3K SYSTEM

- 2.4kg
5.3lb
- 5kg
11lb
- 73cm
28.7in
- 56cm
21.8in
- 148cm
57.7in
- 173cm
67.5in
- 3kg
6.5lb

Head MVH500AH
Tripod Carbon Fiber 755CX3
Bag included



MVH500AH, 755XBK SYSTEM

- 2.4kg
5.3lb
- 5kg
11lb
- 73cm
28.7in
- 51cm
19.9in
- 149,5cm
58.3in
- 174cm
67.9in
- 3,4kg
7.4lb

Head MVH500AH
Tripod Aluminum 755XB
Bag included



variable



fixed



MVH502A



variable



fixed



MVH502AH



MVH502A FLUID VIDEO HEAD - 75MM HALF BALL

The 502 fluid head is designed for use with HD/SLR cameras and latest interchangeable lens cameras. It offers professional features such as high-performance variable fluidity and a counterbalance system. The 502 supports up to 7kg cameras and accessories, with a counterbalance setting designed to match the weight of the most popular cameras and their accessories as external monitors, lights or microphones. The 502's Easy Link attachment points mean that the weight of accessories can be supported directly by the head, rather than by the camera. The MVH502A has a 75mm half ball video tripod mount.



4kg
8.8lb



7kg
15.4lb



15cm
5.9in



1.6kg
3.5lb



504PLONG

MVH502AH FLUID VIDEO HEAD - FLAT BASE

Same characteristics as the MVH502A, but with a flat base mount with standard 3/8" thread. Ideal for tripod/slider/rig/crane application.



4kg
8.8lb



7kg
15.4lb



13cm
5.1in



1.7kg
3.7lb



504PLONG

COUNTERBALANCE GRAPH

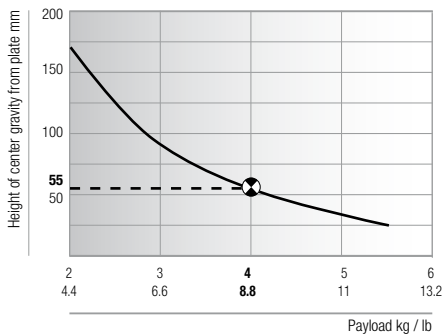

- 1 Sliding plate safety release button
- 2 Pan drag control
- 3 Leveling bubble

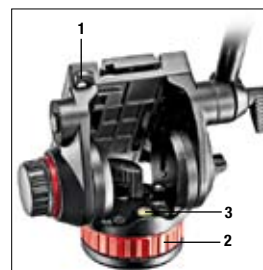

- 1 Pan locking knob
- 2 Tilt drag control
- 3 Easy link connectors



- 1 Tilt locking knob
- 2 Sliding quick release plate
- 3 Sliding quick release knob
- 4 Easy link connectors



TECHNICAL SPECIFICATIONS

Head base	75mm half ball (MVH502A) - Flat (MVH502AH)
Pan drag type	Fixed fluid cartridge (from 0 to max level)
Tilt drag type	Fixed fluid cartridge (from 0 to max level)
Counterbalance weight	Fixed @ 4kg (8.8lb)
Safety payload	7kg (15.4lb)
Leveling bubble	Available
Pan bar	Available

Pan bar attachment	Available on right and left sides
Replaceable pan bar rosette	No
Plate type	504PLONG Quick Release
Plate travel	85mm (3.3in)
Plate attachment	3/8" and 1/4" camera screws + anti-rotation pin
Pan range	360°
Tilt range	-80° +90°
Temperature range	-20° C +60° C



MVK502AM-1 SYSTEM

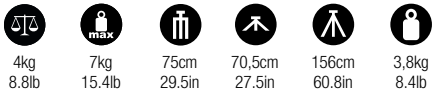

4kg 8.8lb 7kg 15.4lb 75cm 29.5in 70,5cm 27.5in 156cm 60.8in 3,8kg 8.4lb

Head MVH502A
Tripod Aluminum MVT502AM
Mid spreader included
Bag included



MVK502C-1 SYSTEM

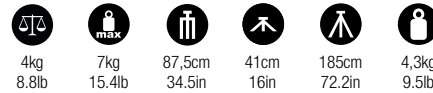

4kg 8.8lb 7kg 15.4lb 87,5cm 34.5in 41cm 16in 185cm 72.2in 4,3kg 9.5lb

Head MVH502A
Tripod Carbon Fiber 535
Bag included



MVH502A, 546BK-1 SYSTEM

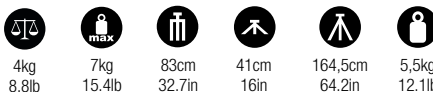

4kg 8.8lb 7kg 15.4lb 83cm 32.7in 41cm 16in 164,5cm 64.2in 5,5kg 12.1lb

Head MVH502A
Tripod Aluminum 546B
Mid spreader included
Bag included



MVH502A, 546GB-1 SYSTEM

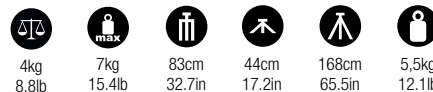

4kg 8.8lb 7kg 15.4lb 83cm 32.7in 44cm 17.2in 168cm 65.5in 5,5kg 12.1lb

Head MVH502A
Tripod Aluminum 546GB
Spreader included
Bag included



504HD FLUID VIDEO HEAD - 75MM HALF BALL

The compact 504HD combines high-performance variable fluidity with a wide variety of professional features, including a 4-step counterbalance system, ergonomic positioning of all knobs for tilt, drag and locking on the left side of the head, illuminated leveling bubble and replaceable pan-bar rosettes. The 504HD designed to support the latest generation of HD cameras weighing up to 12kg (26.5lb) and counterbalancing up to 7.5kg (16.5lb). The 504HD has a 75mm half ball video tripod mount.



7,5kg
16.5lb



12kg
26.5lb



15,5cm
6in



2,9kg
6.4lb



504PLONG

COUNTERBALANCE GRAPH

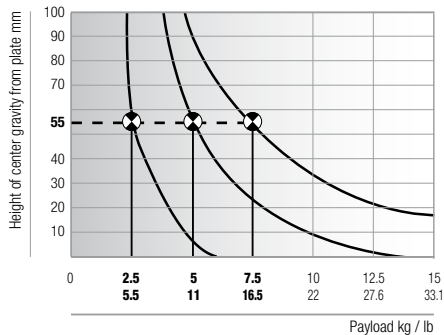

- 1 Pan drag control
- 2 Pan locking knob
- 3 Illuminated leveling bubble



- 1 Tilt locking knob
- 2 Tilt drag knob
- 3 Sliding plate safety release button
- 4 Easy Link - 3/8" thread connection



- 1 Counterbalance adjustment knob
- 2 Sliding quick release plate
- 3 Sliding quick release knob

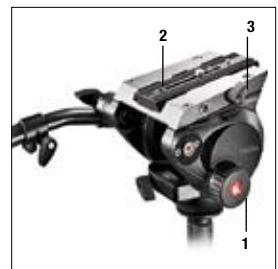







TECHNICAL SPECIFICATIONS

Head base	75mm half ball
Pan drag type	Fixed fluid cartridge (from 0 to max level)
Tilt drag type	Fixed fluid cartridge (from 0 to max level)
Counterbalance system	Variable 4 steps
Counterbalance weight	0 - 2,5 - 5 - 7,5kg (0 - 5.5 - 11 - 16.5lb)
Safety payload	12kg (26.5lb)
Leveling bubble	Available (illuminated with led)
Pan bar	Available (telescopic)

Pan bar attachment	Available on right and left sides
Replaceable pan bar rosette	Yes, on both sides
Plate type	504PLONG Quick Release
Plate travel	92mm (35.9in)
Plate attachment	3/8" and 1/4" camera screws + anti-rotation pin
Pan range	360°
Tilt range	-60° +90°
Temperature range	-20° C +60° C









504HD, 535K SYSTEM

					
7,5kg 16.5lb	12kg 26.5lb	88cm 34.6in	40,5cm 15.8in	184cm 71.8in	5kg 11lb

Head 504HD
Tripod Carbon Fiber 535
Bag MBAG100PN









504HD, 536K SYSTEM

					
7,5kg 16.5lb	12kg 26.5lb	85,5cm 33.6in	40cm 15.6in	217,5cm 84.8in	6,1kg 13.5lb

Head 504HD
Tripod Carbon Fiber 536
Bag MBAG100PN









504HD, 546BK SYSTEM

					
7,5kg 16.5lb	12kg 26.5lb	84cm 33in	44cm 17.2in	167,5cm 65.3in	6,3kg 13.9lb

Head 504HD
Tripod Aluminum 546B
Mid spreader included
Bag MBAG100PN



504HD, 546GBK SYSTEM

					
7,5kg 16.5lb	12kg 26.5lb	84cm 33in	46,5cm 18.1in	171cm 66.7in	6,3kg 13.9lb





Head 504HD
Tripod Aluminum 546GB
Spreader included
Bag MBAG100PN



- variable 
- variable 
- 
- 
- 
- 

509HD PRO FLUID VIDEO HEAD - 100MM HALF BALL

The 509HD fluid head combines ergonomic design features with professional performance. To help you obtain incredibly smooth camera movements and great footage, the 509HD has variable fluid drag and a fast, precise, 4-step counterbalance system that makes it suitable for a wide range of semi-professional and professional camera setups. The 509HD's patented Advanced Balancing Recorder (ABR) allows you to quickly find, store and recuperate the correct balance position of the plate when using a particular combination of equipment. The 509HD also features Easy Link connectors for accessory attachment, an illuminated leveling bubble and replaceable rosettes for pan bar attachment on both sides of the head. The 509HD has a 100mm half ball video tripod mount.

- 
12,8kg - 28.1lb (@ 55 C.O.G.)
8,5kg - 18.7lb (@ 125 C.O.G.)
- 
13,5kg - 29.8lb (@ 55 C.O.G.)
9kg - 19.8lb (@ 125 C.O.G.)
- 
17,8cm
6.9in
- 
3,8kg
8.4lb
- 
509PLONG

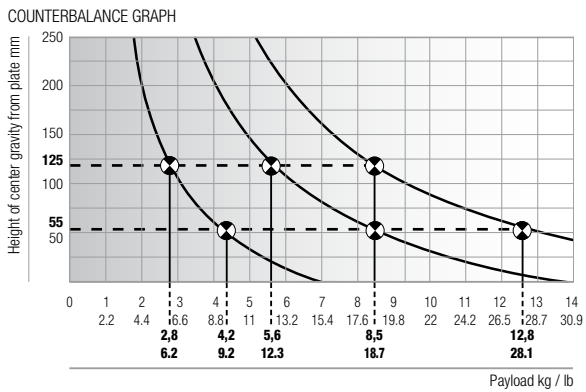

- 1 Pan drag control
- 2 Pan locking knob
- 3 Illuminated leveling bubble



- 1 Tilt locking knob
- 2 Tilt drag knob
- 3 Sliding plate safety release button



- 1 Counterbalance adjustment knob
- 2 Sliding quick release plate
- 3 Sliding quick release knob
- 4 Advanced Balancing Recorder
- 5 Easy Link - 3/8" thread connection



TECHNICAL SPECIFICATIONS

<p>Head base</p> <p>Pan drag type</p> <p>Tilt drag type</p> <p>Counterbalance system</p> <p>Counterbalance weight</p> <p>Safety payload</p> <p>Leveling bubble</p> <p>Pan bar</p>	<p>100mm half ball</p> <p>Fixed fluid cartridge (from 0 to max level)</p> <p>Fixed fluid cartridge (from 0 to max level)</p> <p>Variable 4 steps</p> <p>0 - 2,8 - 5,6 - 8,5kg (0 - 6,2 - 12,3 - 18,7lb)</p> <p>9kg (19.8lb)</p> <p>Available (illuminated with led)</p> <p>Available (telescopic)</p>	<p>Pan bar attachment</p> <p>Replaceable pan bar rosette</p> <p>Plate type</p> <p>Plate travel</p> <p>Plate attachment</p> <p>Pan range</p> <p>Tilt range</p> <p>Temperature range</p>	<p>Available on right and left sides</p> <p>Yes, on both sides</p> <p>509PLONG Quick Release with ABR</p> <p>72mm (2.8.1in)</p> <p>3/8" and 1/4" camera screws + anti-rotation pin</p> <p>360°</p> <p>-60° +90°</p> <p>-20° C +60° C</p>
---	---	--	--



509HD, 536K SYSTEM



12,8kg - 28.1lb (@ 55 C.O.G.)
8,5kg - 18.7lb (@ 125 C.O.G.)



13,5kg - 29.8lb (@ 55 C.O.G.)
9kg - 19.8lb (@ 125 C.O.G.)



87cm
34.2in



40,5cm
15.8in



217,5cm
84.8in



7,1kg
15.7lb

Head 509HD
Tripod Carbon Fiber 536
Bag MBAG100PNHD



509HD, 545BK SYSTEM



12,8kg - 28.1lb (@ 55 C.O.G.)
8,5kg - 18.7lb (@ 125 C.O.G.)



13,5kg - 29.8lb (@ 55 C.O.G.)
9kg - 19.8lb (@ 125 C.O.G.)



84cm
33in



44,5cm
17.4in



168,5cm
65.7in



7,3kg
16.1lb

Head 509HD
Tripod Aluminum 545B
Mid spreader included
Bag MBAG100PNHD



509HD, 545GBK SYSTEM



12,8kg - 28.1lb (@ 55 C.O.G.)
8,5kg - 18.7lb (@ 125 C.O.G.)



13,5kg - 29.8lb (@ 55 C.O.G.)
9kg - 19.8lb (@ 125 C.O.G.)



84cm
33in



48cm
18.7in



172cm
67.1in



7,3kg
16.1lb

Head 509HD
Tripod Aluminum 545GB
Spreader included
Bag MBAG100PNHD



526 PRO FLUID VIDEO HEAD - 100MM HALF BALL

The 526 is a professional, heavy duty, fluid head aimed at high-end ENG and EFP, with a feature set designed to allow cameramen to work quickly and easily under pressure. For example, the 526's large control knobs for tilt/pan lock and tilt drag are all located on the left side of the head for single-handed adjustment, and all the controls are rubber-padded for better grip. The 526 has a very precise fluid drag system with three drag level settings (low, medium and high, numbered 1, 2 and 3 respectively). Drag setting 0 switches off the drag for snap-pans/tilts. Counterbalance is via a continuously adjustable spring for different camera weights.

15g	16kg	15cm	3.6kg	357PLV
33.1lb	35.3lb	5.9in	7.9lb	

- 1 Pan locking knob
- 2 Pan drag control
- 3 Leveling bubble



- 1 Tilt locking knob
- 2 Tilt drag knob
- 3 Counterbalance adjustment knob



- 1 Sliding plate safety release button
- 2 Sliding quick release plate
- 3 Sliding quick release knob
- 4 Interchangeable pan bar rosette



COUNTERBALANCE GRAPH

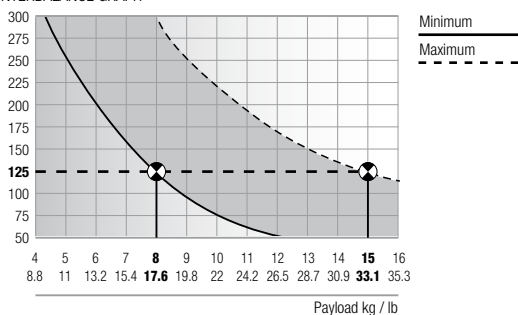

TECHNICAL SPECIFICATIONS

Head base	100mm half ball	Pan bar attachment	Available on right and left sides
Pan drag type	0 plus - 3 steps	Replaceable pan bar rosette	Yes, on both sides
Tilt drag type	0 plus - 3 steps	Plate type	357PLV
Counterbalance system	Variable continuous	Plate travel	80mm (31.2in)
Counterbalance weight	8 - 15kg (17.6 - 33.1lb)	Plate attachment	3/8" and 1/4" camera screws + anti-rotation pin
Safety payload	16kg (35.3lb)	Pan range	360°
Leveling bubble	Available	Tilt range	-70° +75°
Pan bar	Available (telescopic)	Temperature range	-20° C +60° C



526, 536K SYSTEM

15kg 33.1lb	16kg 35.3lb	86cm 33.8in	43cm 16.8in	218cm 85in	6,9kg 15.1lb

Head 526
Tripod Carbon Fiber 535
Bag MBAG100PN



526, 545BK SYSTEM

15kg 33.1lb	16kg 35.3lb	84cm 33in	45cm 17.6in	169cm 65.9in	7,1kg 15.7lb

Head 526
Tripod Aluminum 545B
Mid spreader included
Bag MBAG100PN



526, 545GBK SYSTEM

15kg 33.1lb	16kg 35.3lb	84cm 33in	47,5cm 18.5in	173cm 67.5in	7.1kg 15.7lb

Head 526
Tripod Aluminum 545GB
Spreader included
Bag MBAG100PN



526, 528XBK SYSTEM

15kg 33.1lb	16kg 35.3lb	114cm 44.9in	88cm 34.3in	163cm 63.6in	11kg 24.3lb

Head 526
Tripod Aluminum / Steel 528XB
Mid spreader included
Bag MBAG120PN



TRIPODS

The Manfrotto video tripod range covers a wide variety of applications and user needs, offering both twin-leg and single-leg tripods, with traditional video half-bowl or flat-base head attachments, as well as hybrid video/photo innovations like the MDeVe leveling column. Our tripods are assembled from high-performance components made in carefully chosen raw materials such as carbon fiber, aluminum, magnesium and high-quality technopolymers. When choosing the right tripod, key factors to take into account include the camera setup you need to support and the video head you'll be matching with the tripod, the specific application and environment in which your kit will be used, and characteristics such as compactness, extended height, weight and leg angle settings.

MDeVe tripods are where Manfrotto's video know-how and our long experience in photography meet: our R&D team realized that video supports could benefit from some of the main advantages of photo tripods. They took the lightweight, torsion-resistant, single carbon/aluminum tube leg structure of the photo tripod, with its easily extensible center column, and built a new video-ready 50mm half ball leveling system at the top of the center column. Locked and unlocked via the (detachable) rotating grip at the bottom of the column, the MDeVe system allows the operator to level the camera without needing to make micro adjustments to each individual tripod leg.

The result is a tripod that's as quick to set up as a true photo tripod, but has the fine leveling and torsion resistance demanded by video. MDeVe tripods are ideally suited to use with lightweight camera equipment and in situations where set-up speed is of the essence.



Center column with built-in 50mm half ball locked using the rotating grip located at the bottom of the center column. Tilt range: $+15^{\circ}/-15^{\circ}$.



Single tube leg profile made of round-section aluminum or carbon fiber.



Four different leg angle settings.



Quick action lever leg lock system (45° run).



Rubber feet.



755CX3 MDEVE MAGFIBER VIDEO TRIPOD

Two-stage tripod with a perfect combination of low weight and high load capacity that comes from the use of carbon fiber and magnesium in its construction.

7kg 15.4lb	63,5cm 25in	46,5cm 18.3in	139cm 54.7in	164mm 64.6in	1,9kg 4.2lb

TECHNICAL SPECIFICATIONS 755CX3

Head attachment	50mm leveling flat base with 3/8" screw + extendible center column
Leveling bubble	Yes
Locking type	Lever locks
Leg angle setting	By leg selector
Leg angle	4 steps (23° - 47° - 66° - 89°)
Included spike foot shoes	No



755XB MDEVE ALUMINUM VIDEO TRIPOD

Designed to withstand rugged use and to support professional lightweight camcorders, the 755XB is an extremely versatile tripod. Entirely made from aluminum.

7kg 15.4lb	63,5cm 25in	41,5cm 16.3in	140,5cm 55.3in	165mm 65in	2,5kg 5.5lb

TECHNICAL SPECIFICATIONS 755XB

Head attachment	50mm leveling flat base with 3/8" screw + extendible center column
Leveling bubble	Yes
Locking type	Lever locks
Leg angle setting	By leg selector
Leg angle	4 steps (23° - 45° - 65° - 88°)
Included spike foot shoes	No

MPRO tripods unite performance and functionality. A torsion rigidity superior to that of equivalent aluminum twin-strut tripods, an MPRO tripod offers better protection against “backlash” effects at the end of pan movements. Special carbon fiber tubing and aluminum with a torsional rigidity castings also bring notable weight savings to the MPRO range. This makes them easy to carry and transport. Another feature worth pointing out is that MPRO tripods also offer incredibly versatile and speedy height adjustment anywhere, without needing any accessories.

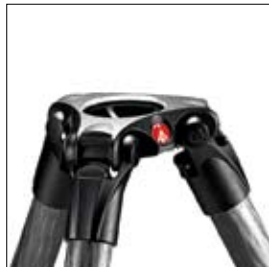

75mm bowl (535 version only).



75/100mm screw-in adaptor (536 version only) to hold the different industry standard half-ball heads.



High-performance Carbon fiber tubes. Lightweight and resistant magnesium die castings.



Ergonomic leg angle selector for a quick, easy and precise angle adjustment.



Quick action ergonomic leg locks.



Retractable spiked feet for in and outdoor use.



75

CF
carbon fiber

2



535 MPRO CARBON FIBER 2-STAGE VIDEO TRIPOD

The 3-section, single-tube 535 video tripod offers great stability, high load capacity and a very useful maximum height. Ergonomic, easy-to-use and compact, it has a 75mm half bowl for compatibility with mid-range video heads. Leg tubes are in carbon fiber, while die castings are in magnesium to keep weight low and performance high. In addition, the 535 has a new leg angle selector, developed for quick, easy and precise independent leg angle adjustments.



20kg 73,5cm 27cm 171cm 2,3kg
44.1lb 28.9in 10.6in 67.3in 5.1lb

TECHNICAL SPECIFICATIONS 535

Head attachment	75mm bowl
Leveling bubble	No
Locking type	Lever locks
Leg angle setting	By leg selector
Leg angle	3 steps (23° - 50° - 70°)
Included spike foot shoes	No



75/100

CF
carbon fiber

3



536 MPRO CARBON FIBER 3-STAGE VIDEO TRIPOD

The 4-section, single tube 536 video tripod is incredibly stable, even though it offers a very high load capacity and a very tall maximum height. Despite its open height, it's compact when folded. The single tube structure makes it light in weight, ergonomic and easy-to-use. Features our new leg angle selector, developed for quick, easy and precise independent leg angle adjustments. The half-bowl attachment fits industry-standard 75mm or 100mm half ball heads; an adaptor is supplied to switch between the two sizes.

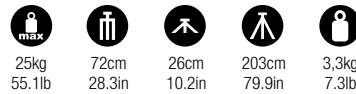

25kg 72cm 26cm 203cm 3,3kg
55.1lb 28.3in 10.2in 79.9in 7.3lb

TECHNICAL SPECIFICATIONS 536

Head attachment	75/100mm bowl
Leveling bubble	No
Locking type	Lever locks
Leg angle setting	By leg selector
Leg angle	3 steps (23° - 50° - 70°)
Included spike foot shoes	No

TELESCOPIC TWIN LEG SYSTEMS The new MVT502AM is a lightweight video tripod built with innovative telescopic twin elliptic tube legs. The two-stage structure makes the tripod more compact and more stable. As a result, the MVT502AM is a perfect solution for those looking for a tripod that offers transportability without sacrificing performance.



Made of elliptic aluminum tubes, our new telescopic leg is the product of extensive research into lightweight applications; it allows the tripod to be extra stable.



New innovative design reduces the weight of the system without any loss in performance.



The two-stage telescopic legs reduce the size of the tripod when folded.



For easier and safer transportation.



Thanks to the improved clamping mechanism, the new higher spreader allows the tripod to be set up faster and easier.



The 75mm bowl guarantees the perfect position can be achieved at any angle between -15° and $+15^\circ$.



New leg locking system with ergonomic levers enables the easy locking of the elliptic telescopic tubing in any position.



MVT502AM TELESCOPIC-TWIN LEG TRIPOD

The MVT502AM is a two-stage tripod for lightweight applications. Its telescopic-twin legs are made of elliptical aluminum tubes that help reduce torsion and give the tripod a good balance of high performance and reduced weight. Other features include a fixed mid-level spreader for increased rigidity and faster set-up, a rubber strap for safer, easier transportation, and new high-grip soft rubber feet. The MVT502AM's 75mm half-bowl matches mid-range Manfrotto video heads.



15kg
33.1lb



61,5cm
24.2in



57cm
22.4in



143,5cm
56.5in



1,95kg
4.3lb

TECHNICAL SPECIFICATIONS MVT502AM

Head attachment	60/75mm bowl	Included mid spreader	Yes
Leveling bubble	No	Included ground spreader	No
Locking type	Lever locks	Included spike foot shoes	No
Leg angle setting	Not setting		
Leg angle	19°		

The **PRO** series fits neatly into the PRO range of video tripods: it has an aluminum top casting allowing it to be used with our professional half-ball video heads with Ø 100mm or 75mm fittings; its aluminum twin-strut legs feature adjustable locking levers that can be tension-set to guarantee complete locking power even after years of use and wear; the spiked feet with removable rubber shoes are suitable for any surface from smooth, delicate floors to uneven ground.



Built-in half bowl (Ø 100mm or 75mm)



Mid or ground spreader for improved tripod stability.



Spreader length regulation.

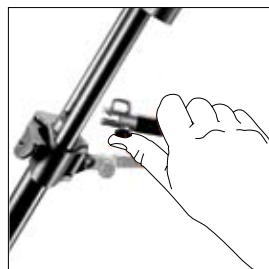

New spreader attachment.



Rubber shoes guarantee a better grip on smooth floors.



Newly redesigned collars, integrated in the overall product ergonomics for improved rigidity.



545B PRO HEAVY-DUTY VIDEO TRIPOD

Two-stage, extremely rigid, professional video tripod. Able to carry loads up to 25kg (55.1lb). The 545B has a die cast aluminum crown with a 100mm half-bowl (code 319 is available as accessory to convert it to 75mm). The 545's leg locks are secure and reliable, and spiked feet with rubber overshoes are provided for solid grounding on both uneven terrain and smooth floors. The tripod can be used with various dollies. The 545B has a telescopic mid-level spreader to help set leg angles accurately.

25kg 55.1lb	69cm 27.2in	30cm 11.8in	154cm 60.6in	3.5kg 7.7lb

TECHNICAL SPECIFICATIONS 545B

Head attachment	100mm bowl
Leveling bubble	No
Locking type	Lever locks
Leg angle setting	By mid spreader
Leg angle	From 30° to 66°
Included mid spreader	Yes
Included ground spreader	No
Included spike foot shoes	Yes



545GB PRO HEAVY-DUTY VIDEO TRIPOD

The 545GB is the same as the 545B, except that it has a telescopic ground-level spreader instead of a mid-level spreader.

25kg 55.1 lb	69cm 27.2in	32,5cm 12.8in	158,5cm 62.4in	3,5kg 7.7lb

TECHNICAL SPECIFICATIONS 545GB

Head attachment	100mm bowl
Leveling bubble	No
Locking type	Lever locks
Leg angle setting	By ground spreader
Leg angle	From 29° to 63°
Included mid spreader	No
Included ground spreader	Yes
Included spike foot shoes	No



546B PRO VIDEO TRIPOD

Two-stage, extremely rigid, professional video tripod, able to carry loads up to 20kg (44lb). The 546B has a die cast aluminum crown with a built-in 75mm bowl. Leg locks are secure and reliable, and spiked feet with rubber overshoes are provided for solid grounding on both uneven terrain and smooth floors. The tripod can be used with various dollies. The 546B has a telescopic mid-level spreader to help set leg angles accurately.



20kg 69cm 30cm 154cm 3,5kg
44lb 27in 11.8in 60.6in 7.7lb

TECHNICAL SPECIFICATIONS 546B

Head attachment	75mm bowl
Leveling bubble	No
Locking type	Lever locks
Leg angle setting	By mid spreader
Leg angle	From 30° to 66°
Included mid spreader	Yes
Included ground spreader	No
Included spike foot shoes	Yes



546GB PRO VIDEO TRIPOD

The 546GB is the same as the 546B, except that it has a telescopic ground-level spreader instead of a mid-level spreader.



20kg 69cm 32,5cm 158,5cm 3,5kg
44lb 27in 12.8in 62.4in 7.7lb

TECHNICAL SPECIFICATIONS 546GB

Head attachment	75mm bowl
Leveling bubble	No
Locking type	Lever locks
Leg angle setting	By ground spreader
Leg angle	From 29° to 63°
Included mid spreader	No
Included ground spreader	Yes
Included spike foot shoes	No



528XB PRO HEAVY VIDEO TRIPOD

The 528XB is the ideal location tripod, with a massive 50kg (110.2lb) load capacity. Tubes are made of stainless steel for strength under heavy loads, and aluminum for reducing the weight. The leg spread is fully adjustable, but also incorporates a 30° locked position for faster set up and greater strength. The 528XB includes a versatile mid-level spreader, which has telescopic “ratchet” braces that click into place in each of the preset positions for faster deployment. Each brace can be individually set, allowing each tripod leg to be separately positioned.

50kg 110.2lb	99cm 39in	73cm 28.7in	148cm 58.3in	7.4kg 16.3lb

TECHNICAL SPECIFICATIONS 528XB

Head attachment	100mm bowl + half ball included
Leveling bubble	No
Locking type	Knob locks
Leg angle setting	By mid spreader
Leg angle	From 25° to 41°
Included mid spreader	Yes
Included ground spreader	No
Included spike foot shoes	No



117B PRO VIDEO TRIPOD

The 117B features a geared central column that permits a fine adjustment of the camera height. The base is assembled using stainless steel extension legs for extreme corrosion resistance and extra long working life. The middle spreader is assembled with aluminum telescopic tubes that make the tripod flexible and rigid. Rubber feet and retractable metal spikes are included.

18kg 39.7lb	94cm 37in	46cm 18.1in	147cm 57.9in	5.7kg 12.6lb

TECHNICAL SPECIFICATIONS 117B

Head attachment	Flat base with 3/8" screw + extendible center column
Leveling bubble	No
Locking type	Knob locks
Leg angle setting	By mid spreader
Leg angle	From 10° to 60°
Included mid spreader	Yes
Included ground spreader	No
Included spike foot shoes	No

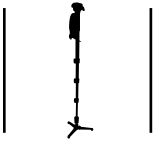

MONOPODS

When shooting space is limited, when the amount and weight of equipment has to be kept to a minimum, or when set-up speed is of primary importance, a monopod is often the best solution to helping support a video camera and reduce camera shake. Monopods combine flexibility with high performance and fluidity, and can be useful in a vast range of situations and locations, many of which would be unsuitable for a tripod.

FLUID MONOPODS are a Manfrotto world-first; a patented system designed to help videographers obtain superior image quality from the kind of fluid camera movements unachievable with a standard monopod. An innovative fluid cartridge is incorporated in the base of the monopod to make panoramic rotations of the camera as smooth and judder-free as possible. The monopod base also has three retractable feet, which give a firmer footing, helping to keep the camera stable and reduce unwanted tilt.



The key feature of this monopods family is the fluid cartridge incorporated into the base that gives you an incredibly smooth panning action.



The three retractable feet ensure a firm footing and a great compactness while folded.



MVM500A FLUID VIDEO MONOPOD WITH 500 HEAD

The MVM500A is a fluid monopod with a specially adapted 500 video head attached. Combining the flexibility, reduced weight and innovative fluid pan cartridge of the monopod with the features of the head – its counterbalance system, tilt fluidity and locking, fast and secure side lock plate system, accessory Easy Link and pan bar – helps you get better footage from your camera than you would have thought possible with a monopod. Supplied with retractable feet.



2,4kg
5.3lb



5kg
11lb



77cm
30in



200,5cm
78.2in



2,1kg
4.7lb



500PLONG



560B-1 FLUID VIDEO MONOPOD

Compact and lightweight 4-section aluminum monopod with a fluid pan cartridge and a quick release tilt top with lock knob at the top gives you more flexible shooting angles and faster camera attachment without sacrificing the compactness of the monopod. Supplied with retractable feet.



2kg
4.4lb



65,5cm
25in



166cm
64.7in



0,9kg
1.9lb



200PL-14



562B-1 FLUID VIDEO MONOPOD

The 562B is a compact and high 4-section aluminum fluid monopod equipped with a 357PLV sliding camera plate adapter to adjust the camera's center of balance. This fluid monopod is ideal for camcorders up to 8kg (17.6lb). Supplied with retractable feet.



8kg
17.6lb



69cm
26.9in



193cm
75.3in



1,4kg
3.2lb



357PLV



SYMPLA FIG RIG SYSTEM

Hybrid DSLR cameras and ever-smaller, lighter camcorders with interchangeable lens offer many advantages and opportunities, but also bring new problems to solve: much of the latest camera equipment doesn't have the ergonomic form needed for steady shoulder-mounted or hand-held footage. Sympla is Manfrotto's solution to those problems: a modular video rig system that extends and complements new cameras, allows for stable support and framing, and supports essential accessories. Offering versatility and high performance as well as comfort and safety, Sympla is designed to be much easier and faster set up than other solutions. Every component and assembly can be changed easily and fine-tuned quickly without any tool, giving you whatever you need to get the shot, the second you need it. Everything at your fingertip.

One of the key advantages of Sympla is its full compatibility with our video remote control or the revolutionary range of HD SLRs camera remotes. The remotes fit Sympla handgrips, allowing precise control of framing and camera functions without moving your hands from the grip or your eyes from the viewfinder, helping you capture stable, usable, creative footage. And Sympla can quickly be extended: whether you start from one of our kits, or from single components, you can quickly build the exact rig you need for the shot.







MVA511WK-1 SHOULDER MOUNTED RIG

This rig allows support of camera equipment on your shoulder, with swivel-joint handles for perfect control and flexibility. The Shoulder Mounted Rig is ideal for use with HDSLRs and interchangeable lens camcorders, featuring fast camera connection thanks to the sliding plate with quick release. The Variable Plate is one of the most important components of the rig. This element permits to quickly adjust the position of the camera in combination with all the other accessories used, as the mattebox. The video equipment, such as HDSLR or Camcorder, can be easily controlled accessorizing this rig with the new HDSLR Remote Controls (ref. MVR911ECCN pag. 46 and MVR911EJCN pag.48). They put camera functions at your fingertips while letting you keep a firm grip on both handles.

Kit comprises: Shoulder Mount, Shoulder Pad, 300mm Rods (4), Variable Plate, 160mm H-Offset, Adjustable Handles, Spacers for handles (2), Clips (2), Rod Connectors (2), Light Counterweight, Spacer for Counterweight with adaptor

We recommend: Mattebox MVA512W, Clamp On HDSLR Remote Control MVR911ECCN Joystick HDSLR Remote Control MVR911EJCN.



MVA525WK LIGHTWEIGHT SHOULDER MOUNTED RIG

This rig, is the Manfrotto lightweight solution that allows support of camera equipment on your shoulder, with swivel-joint handles for perfect control and flexibility. The Lightweight Shoulder Mounted Rig is ideal for use with latest HD SLRs, featuring fast camera connection thanks to RC2 quick release plate. The camera and its lens can be easily controlled accessorizing this rig with the new HD SLR Remote Controls (ref. MVR911ECCN pag. 46 and MVR911EJCN pag.48). They put camera functions at your fingertips while letting you keep a firm grip on both handles.

Kit comprises: Shoulder Mount, Shoulder Pad, 300mm Rods (2), 150mm Rods (2), RC2 Mount, 80mm H-Offset, Adjustable Handles, Spacers for handles (2), Clips (2), Rod Connectors (2), Light Counterweight, Spacer for Counterweight with adaptor.

We recommend: Clamp On HD SLR Remote Control MVR911ECCN Joystick HD SLR Remote Control MVR911EJCN.



MVA512WK-1 FLEXIBLE MATTEBOX SYSTEM

The multi-purpose Flexible Mattebox holds 4x4" filters and protects the lens from stray light, while also permitting fast lens changes. The included Variable Plate component, with its vertical and lateral micro-adjusters, allows easy and precise alignment of the lens with the Flexible Mattebox. Compatible with all Manfrotto Video Heads.

Kit comprises: 300mm Rods (2), Sympla Flexible Mattebox, Sympla Variable Plate, Clips (2).

We recommend: Lens Support, Remote Controls.

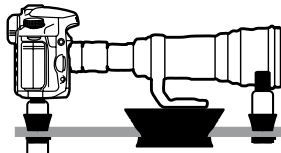

MVA513WK-1 LONG LENS SUPPORT SYSTEM

The Long Lens Support reduces the vibrations generated while shooting with long lenses and gives a rigid, stable platform for filming with any camera/lens combination. Compatible with all Manfrotto Video Heads.

Kit comprises: 300mm Rods (4), Sympla Variable Plate, Sympla Lens Support, Sympla Body Support, Sympla V-Offset, 150mm Rods (2) and Clips (2). We recommend: Offset, Shoulder Pad, Adjustable Handles.



MVA525W RC2 MOUNT

The RC2 mount is a lightweight solution in order to combine video equipment such as HD SLRs or light camcorders, with rail system. Thanks to its design, it is possible to adjust the operating height of the camera in two different positions, depending on the size of the body and the dimension of the lens. The RC2 quick release plate allows fast and secure connection between the camera and the rig.

- Camera attachment: Manfrotto RC2 quick release plate
- Material: Aluminum
- Load Capacity: 5kg (11lb)
- Weight: 0,29kg (0.63lb)



MVA513W FIXED PLATE

The Fixed Plate slides and holds the camera on Sympla rails for front-rear positioning. A single, easy to use repositionable ratchet lock blocks movement. No tools are required for plate adjustments.

- Camera attachment: Manfrotto 504PLONG quick release video plate.
- Accessory attachments: 2 x 3/8" Easy Link
- Underside: 2 x female 3/8" threads (for monopod, tripod or video head QR plate)
- Materials: durable aluminum and steel construction
- Load capacity: 5kg (11lb)
- Weight: 0,96kg (2.2lb)



MVA515W VARIABLE PLATE

The Variable Plate allows precise, fast camera positioning on 3 axes of movement. The plate has a repositionable ratchet quick-lock for each axis, and an intuitive fingertip control each for vertical and lateral geared micro-adjustments. The camera is held safely in place even before its position is locked down, allowing for single-handed adjustments and fine-tuning. The Variable Plate offers the versatility essential for alignment of different camera and lens combinations with the Sympla Flexible Mattebox, and for comfortable use of viewfinders and accessories. No tools are required for plate adjustments.

- Camera attachment: Manfrotto 504PLONG quick release video plate.
- Accessory attachments: 2 x 3/8" Easy Link
- Underside: 2 x female 3/8" threads (for monopod, tripod or video head QR plate)
- Materials: durable aluminum and steel construction
- Load capacity: 5kg (11lb)
- Weight: 1,16kg (2.55lb)



MVA518W ADJUSTABLE HANDLES

Sympla Adjustable Handles are fitted on a Universal Mount by two arms that can be angled independently. The handles are mounted on pivoting ball joints for easier adjustment: a twist of the single locking dial on each handle loosens or blocks all movement, allowing them to be rotated freely and quickly set at the exact position and angle required. The handles can be set in customary vertical or near-vertical positions, but also horizontally like motorbike handlebars. When a Sympla rig is mounted on a video head, the handles can be used as double pan bars.

Thanks to the Universal Mount, the Adjustable Handles can be easily removed and inverted to the upside down configuration.

The PVC-free Adjustable Handles are supplied with two metal spacers that can be fitted to lengthen the arms. The same spacers also adapt the handles for use with Manfrotto's clamp and joystick remote control units.



MVA523W-1 RODS - 150MM

A pair of 150mm (5.9") long Sympla rails, including 1/2"-13UNC screw junctions, with standard 15mm (0.59") diameter.



MVA520W-1 RODS - 300MM

A pair of 300mm (11.8") long Sympla rails, including 1/2"-13UNC screw junctions, with standard 15mm (0.59") diameter.



2 precision-machined aluminum holders for 4x4" photographic filters (1 fixed holder, 1 rotating holder for polarisers). Elasticated textile lens seal fits common lens diameters.

MVA512W FLEXIBLE MATTEBOX

The Sympla Flexible Mattebox is designed for cameras with interchangeable lenses; fitted on a Universal Mount, it slides backwards and forwards along Sympla rails, and has 50mm (1.96") of vertical travel so that it can be aligned with lenses of different lengths and heights. The mattebox has an elasticated textile lens seal that fits common lens diameters, and is built around a 90° swivel joint, which rotates the mattebox out of the way for fast lens changes. The weight of the Flexible Mattebox is fully supported by the Sympla rails (not by the camera lens) reducing stress on the camera's easily-damaged lens mount. Two 4x4" filters can be held in front of the lens –one of the filter holders rotates through 360 degrees, to allow a polarising (or graduated) filter to be angled correctly.

The concertina rubber light hood is opened or closed, partially or fully, in an instant. More versatile than the traditional French flag design, it can shield unwanted directional glare from any angle without blocking light from the rest of the scene; in many cases, that can make a direct difference to the f-stop that can be used. Because the hood is flexible in length, it's universally compatible with lenses from wide-angle to tele. It packs flat for transportability and, when open, protects the lens against knocks and scrapes. Being made of rubber, it won't hurt anyone who accidentally bumps into it... which means it's much safer for use in crowded places or close to sporting events. Another benefit of the flexible hood is that it can be used when shooting at an angle through glass: position the camera and extend and angle the hood so it forms a seal against the glass, thereby cutting out reflections. Repositionable ratchet locks on all movements.



THE HOOD OPENS TO VARIOUS LENGTHS DEPENDING ON LIGHT AND LENS ANGLES



THE HOOD CAN SHIELD AGAINST GLARE FROM ANY SPECIFIC DIRECTION WITHOUT BLOCKING LIGHT FROM OTHER ANGLES



MVA511W-1 PADDED SHOULDER MOUNT

The aluminum shoulder mount is assembled together with the Universal Mount in order to offer both, sturdy connection with the rods and lightness. The padding is developed to guarantee the best comfort and ergonomics in all Sympla configurations. A 3/8" thread is available to be used with a counterweight so the front-mounted load can be properly balanced. We recommend: Counterweight MVA521W, Light Counterweight MVA521L, Spacer for Counterweight MVA521.



MVA524W V-OFFSET

The V-Offset is used when a large height difference needs to be bridged, for example when using a very long tele lens with a tall front lens element.



MVA521W COUNTERWEIGHT

Each counterweight weighs 1,6kg (3.5 lbs), and screws securely on to the SYMPLA Shoulder Pad via 3/8" thread. Counterweights can also be stacked to offset very unbalanced loads. We recommend: Spacer for Counterweight MVA521.



MVA521L LIGHT COUNTERWEIGHT

Each counterweight weighs 0,8kg (1.8lbs), and screws securely on to the Sympla Shoulder Pad via 3/8" thread. Counterweights can also be stacked to offset very unbalanced loads. We recommend: Spacer for Counterweight MVA521.

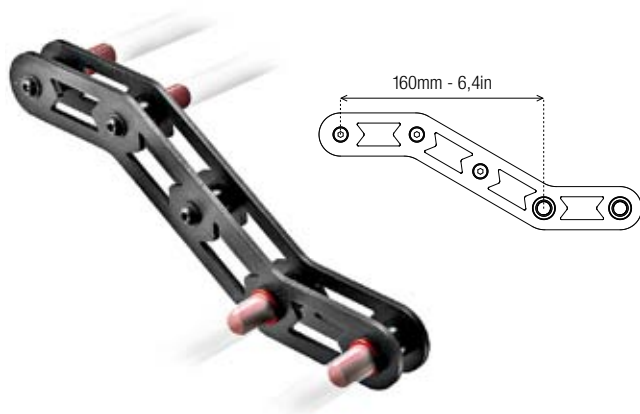

MVA519W 160MM H-OFFSET

The H-Offset is normally used to join an off-center Shoulder Mount to a set of rails directly in front of the camera operator, so that the camera viewfinder or LCD screen can be more comfortably positioned and the weight of the camera and rig more ergonomically distributed.



MVA519S 80MM H-OFFSET

The H-Offset is normally used to join an off-center Shoulder Mount to a set of rails directly in front of the camera operator, so that the camera viewfinder or LCD screen can be more comfortably positioned and the weight of the camera and rig more ergonomically distributed.



MVA522W FIG RIG - SYMPLA VERSION

The Sympla version of the Fig Rig has a Universal Mount in the center of the wheel so that Sympla rails can be fitted, allowing other components and kits such as the Long Lens Support or Flexible Mattebox to be attached.



MVA522 FIG RIG - SYMPLA ADAPTOR

Starting from standard Fig Rig, this accessory allows the user to assemble an Universal Mount in the center of the wheel so that Sympla rails can be fitted.

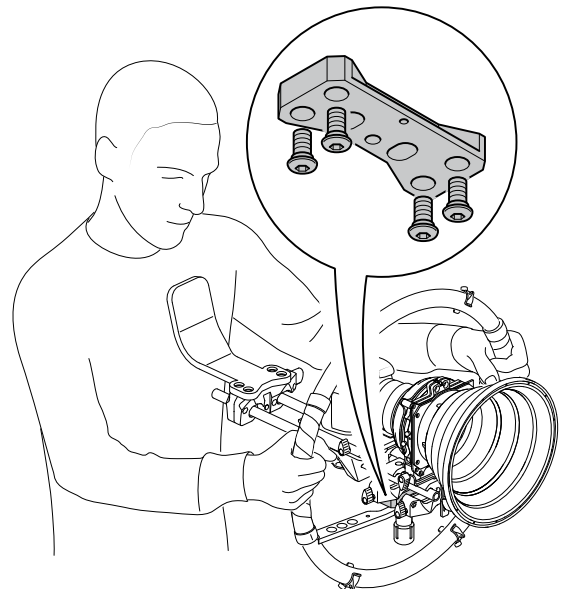



MVA517W UNIVERSAL MOUNT

The Universal Mount has an “open hook” design, which allows it to be inserted and hung on the Sympla rails from below, even between other elements that have already been positioned. Because it’s self-supporting even when unlocked, it stays safely attached to the rails at all times. A single, repositionable locking lever conveniently blocks the Universal Mount solidly against both rails with one movement. The Universal Mount is extremely versatile, thanks to its 4 x 3/8” female threads and 2 x 1/4” female threads, which can be used to attach arms, adaptors and other components and accessories.

- Construction: aluminum fusion for reliability and robustness.
- Weight: 0,29 kg (0.63 lbs)



MVA516W BODY SUPPORT

The Sympla Body Support has a flat rubber-coated bar that can be raised until it rests solidly against the underside of your camera body in order to stop it from vibrating when the lens L-bracket is being used to connect the camera to Sympla. A repositionable ratchet locking lever blocks height adjustment.

- Height range: 0 to 30mm (1.18”). For a greater height range, an additional Sympla V-Offset can be used.



MVA514W LENS SUPPORT

The Sympla Lens Support has a rubber-coated V-profile element that can be raised until it rests solidly against the lens in order to stop it from vibrating when the lens L-bracket is being used to connect the camera to Sympla. A repositionable ratchet locking lever blocks height adjustment.

- Height range: 0 to 30mm (1.18”). For a greater height range, an additional Sympla V-Offset can be used.

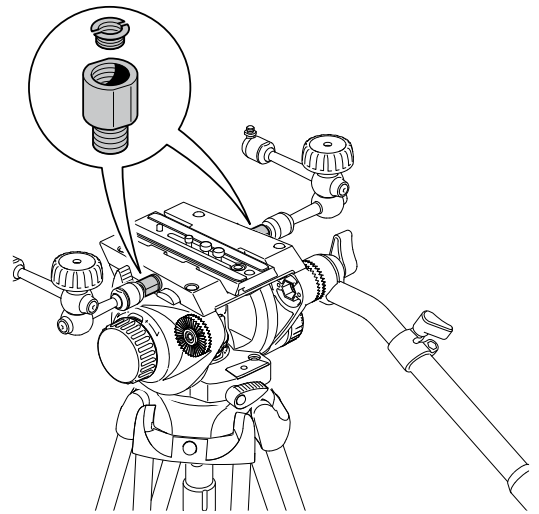

MVA500 EASY LINK CONNECTORS

Easy Link 3/8" connector to allow an external monitor or other accessory equipment to be fitted. It allows to support an external monitor or other accessories. Suitable for bridging heads and Sympla plates.

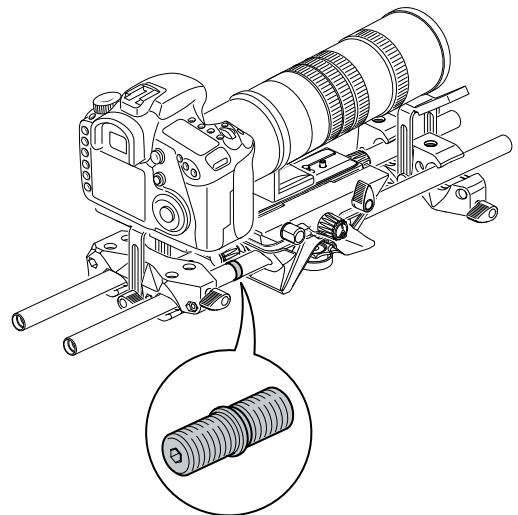

MVA520 CONNECTORS FOR RODS

Aluminum red anodized connectors for rods. They feature a 1/2" - 13UNC screws in order to precisely connect two different rods.

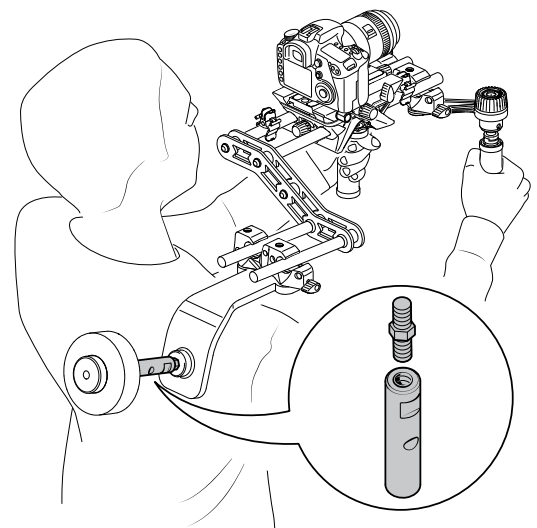

MVA521 EXTENSION TUBES FOR COUNTERWEIGHT

Aluminum spacer that moves the counterweight further back which effectively decreases the weight in front of the shoulder. It provides more balanced to the rig making shooting easier and more stable.

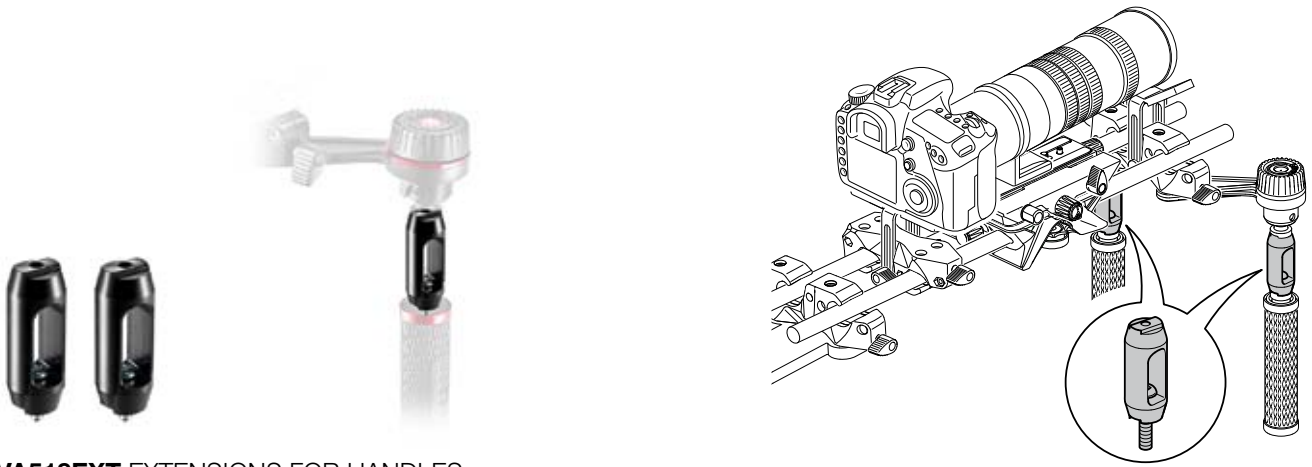

MVA518EXT EXTENSIONS FOR HANDLES

These machined aluminum spacers can be easily fitted on the adjustable handles to lengthen the arms. The same spacers also adapt the handles for use with Manfrotto clamp and joystick remote control units (ref. MVR911ECCN pag. 46 and MVR911EJCN pag.48).

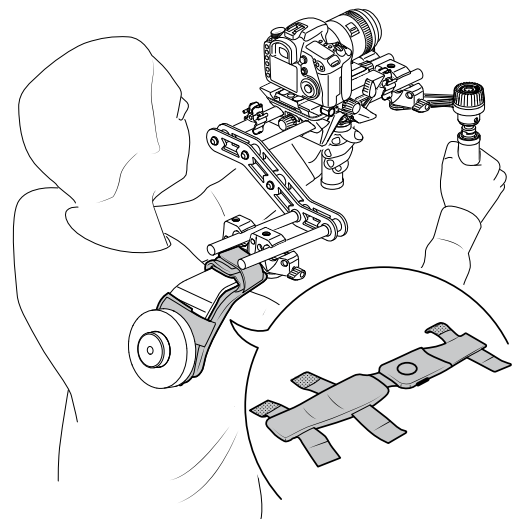

MVA511P PADDING FOR SHOULDER MOUNT

Removable padding for shoulder mount. Developed to guarantee the best comfort and ergonomics in all Sympa configurations. It can be fitted with both, MVA511W-1 and MVA511W.



FIG RIG

The Fig Rig is more than just a steady support. It is a frame on which to build your system. Your camera has only one hot-shoe for accessories, limiting you to one light or one monitor. With the Fig Rig, you can mount any number of accessories that are necessary for today's cameras. Customize the Fig Rig to your liking. Manfrotto provides all the tools to allow you to create your own supporting system.



Each side of the camera bar is threaded with one 1/4", 3/8" and 5/8" hole for additional accessory mounting.



A non-slip rubber pad provides stability when using the Fig Rig on a flat surface such as a table, floor or railing.



Supplied with a 501PL sliding QR plate allowing you to position and balance your camera. The plate system can be switched out with a variety of Manfrotto plate assemblies to best match your camera.



595B FIG RIG

After years of using the Fig Rig on his award-winning films, Mike Figgis brought his idea to Manfrotto. An idea that is non-traditional in design, but purely simple and effective. The only modular system in the world to smoothly support the DV camera and act as a frame to mount all the accessories – including zoom controllers, mics, mixers, lights, monitors, arms...

A circular frame with a crossbar to mount most mini DV cameras, the Fig Rig becomes part of the body to produce smooth, steady travelling shots. It is this very fact which is the secret to the Fig Rig. As the operator walks, his/her muscles and tendons absorb all the shocks, transferring only fluid movements to the camera. As there are no straps or harnesses attached to the Fig Rig, quick and wide movements can be made within the same shot, from ground-level to overhead, in one smooth movement. The camera, accessories and operator become one, allowing you to film scenes quickly and unobtrusively. With the Fig Rig your creativity is virtually limitless.



MICC1 MICROPHONE CLIP

Standard type microphone clip.



MICC4 UNIVERSAL SHOCK MOUNT MICROPHONE HOLDER

Rubber dampening system to absorb vibrations. Swiveling yoke has 3/8" threaded hole.



595CLA FIG RIG CLAMP

Clamp specifically designed for the Fig Rig. Supplied with 1/4" and 3/8" screws, and female 1/4"-3/8" adapter.



ON-CAMERA LIGHTS AND MONITORS: position your light or monitor anywhere around your camera, freeing you up to take it off your hot-shoe.

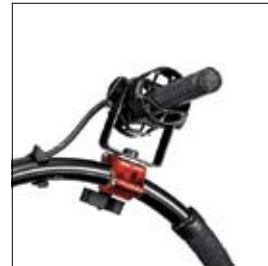

MICROPHONES: mount your shotgun mic anywhere around the camera.



LOW-ANGLE STABILITY: quickly mount the Fig Rig to any 5/8" stud for either temporary storage of stable low-angle shots.



MICC2 MICROPHONE SPRING CLIP

Universal type microphone clip. Grabs microphones from diameter 20 to 35mm (0.8 to 1.4in).



MVA522 FIG RIG - SYMPLA ADAPTOR

Starting from standard Fig Rig, this accessory allows the user to assemble an Universal Mount in the center of the wheel so that Sympla rails can be fitted.



REMOTE CONTROLS

Manfrotto remote control units put the most important commands of market leading video cameras, HD SLRs and lenses at your finger-tips. The range includes the world's first true electronic HD SLR remote controls - connected to the camera body via USB cable. They directly interface with camera and lens firmware protocols for optimum control over functions including focus, record start & stop, photo/video switching and shutter release, live view, digital zoom, aperture and exposure, ISO and more besides. Remote control unit firmware can be updated via USB.

Our remote control range includes both pan-bar and clamp-on models:

- pan-bar versions fit directly on Manfrotto fluid video heads and allow the cameraman to operate both head movement and camera features. He commands with one hand without having to touch the camera itself, which helps eliminate camera shake.
- Clamp-on versions are incredibly compact and can be attached to tubes, pipes, tabletops, Fig Rigs, handlebars and more. By extending the USB cable between the camera and the remote, clamp-on versions can be ideally suited for longer distance control, as slider or crane applications.

Both types of remote control are compatible with SYMPLA rigs and our Bridging Technology™ head range.

REMOTE CONTROLS FOR HD SLR A brand new range of Manfrotto remote controls for Canon HD SLRs promises a real innovation in the field of HD SLR filming – electronic remote control that works by interfacing with camera and lens firmware.

MVR911ECCN CLAMP-ON HD SLR REMOTE CONTROL for Canon

By interfacing directly with camera protocol via USB, the clamp-on electronic remote allows focus operations and main camera functions to be controlled from an extremely compact unit that attaches to a Sympla grip or other bar/pipe, remotely and without direct contact with the camera lens. This means lenses can be swapped easily without adjustment, camera movement is reduced to a minimum, and one-man camera operation is easier. In- and out- focus points and focusing speed can be set, auto-focus used, recording started & stopped, still images taken, and more besides. Fingertip control of key camera functions without moving the hand from the Sympla handles makes support more stable and secure.

- 3-step, ultra-precise focus speed
- Fixed or variable focus control modes
- Customizable focus speed limit
- Focus Memory settings
- Live View control
- Auto Focus control
- Live View Digital Zoom control
- Video recording start/stop
- Photo shutter release
- Remote control battery status
- Customizable focus direction
- Recording LED
- Video and Photo LED
- Clamp fits the spacer supplied with Sympla Adjustable Handles, or round tubes/pipes/bars/pan bars between 12mm (0.47") and 23mm (0.90") in diameter

Check the chart on the Manfrotto Web site for updates and new compatible cameras.





FRONT

- Autofocus
- Live View and Focus Memory 1
- Digital Zoom and Focus Memory 2
- Rec/Stop (video) and Shutter release (photo)
- Focus knob



LEFT SIDE

- Focus speed limit dial
- Focus mode switch – variable or fixed



RIGHT SIDE

- On / Off switch



TOP SIDE

- USB connection - to camera USB port.
- Extended length of supplied cable: 50cm
- Power connection to battery housed in lower shell of the clamp



BACK

- Battery housing (2 x AAA)

MVR911EJCN JOYSTICK HDSLR DELUXE REMOTE CONTROL for Canon

The Deluxe Remote Control is designed to be used as one of the hand grips of a Sympla shoulder support, where it means that a single camera operator can properly support the weight of the camera and rig to ensure smooth, accurate framing and movement, while also controlling all camera functions, without removing either hand from the rig. The Deluxe version can also be used hand-held and away from the camera and its support, it can be attached to video head pan bars or set up in any number of alternative configurations.

It electronically controls focus and both main and advanced camera operations and settings. The LCD screen on Manfrotto's Deluxe version remote relays general information from the camera, such as battery charge level, white balance temperature and memory card status – especially useful if the camera's on-body screen is inaccessible.

- 3-step, ultra-precise focus speed
- Fixed or variable focus control modes
- Customizable focus speed limit
- Focus Memory settings
- Live View control
- Auto Focus control and Auto Focus point selection
- Live View Digital Zoom control
- Video recording start/stop
- Photo shutter release
- Remote control and camera battery status
- Customizable focus direction
- ISO
- Shutter speed
- Aperture
- Colour temperature
- Exposure level

Check the chart on the Manfrotto Web site for updates and new compatible cameras.

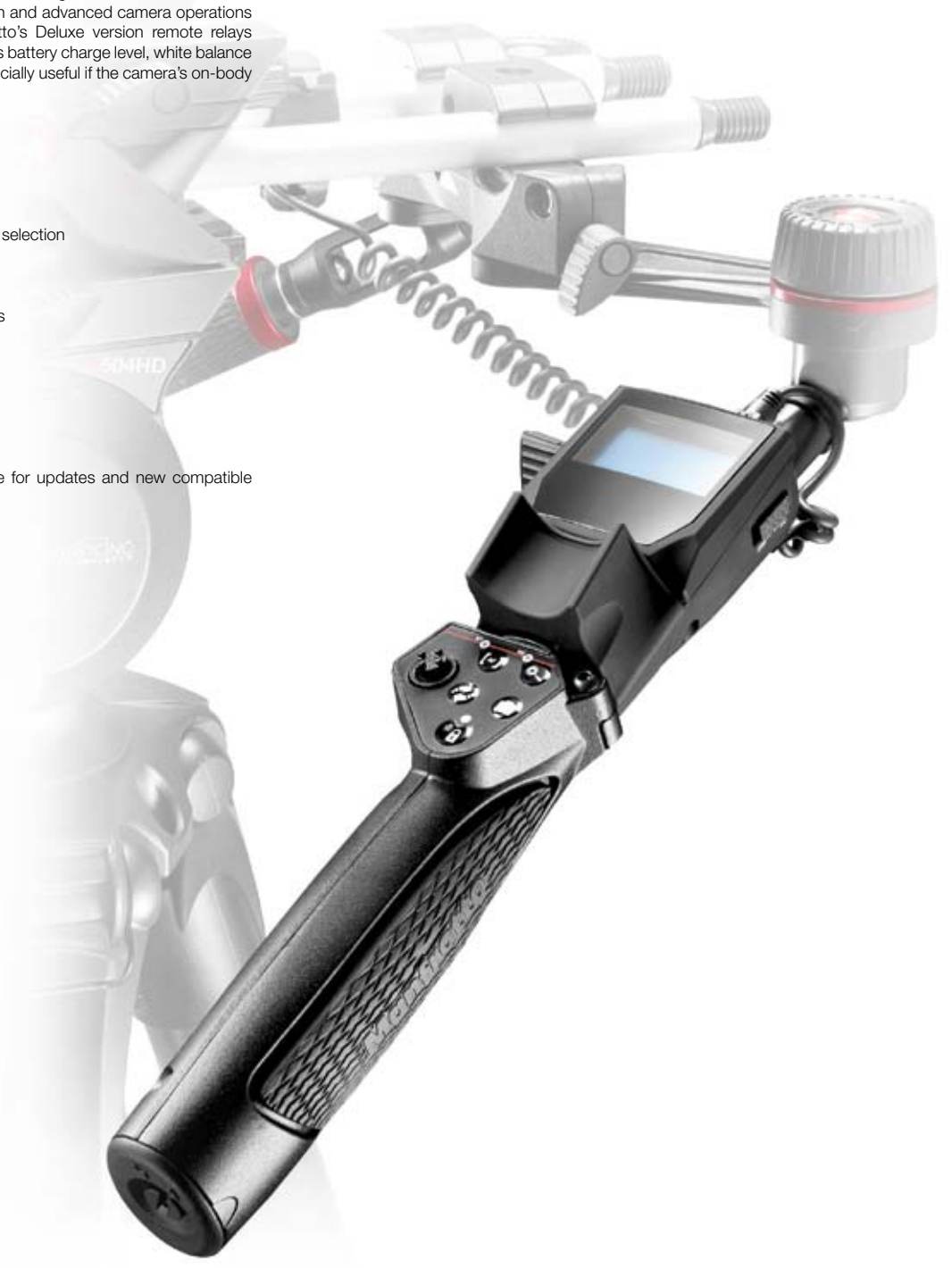



FRONT

- Display screen (see schematic diagram)
- Focus knob
- Autofocus and Focus Memory 1
- Digital Zoom and Focus Memory 2
- Autofocus joystick
- Photo / Video mode switch
- Live view
- Function lock and backlight



BACK

- Focus speed limit and Menu set-up dial



LEFT SIDE

- Rec/Stop (video) and Shutter release (photo) button



RIGHT SIDE

- USB connection - to camera USB port. Extended length of supplied cable: 50cm
- On/Off switch
- Batteries (4 x AA) housed in handgrip

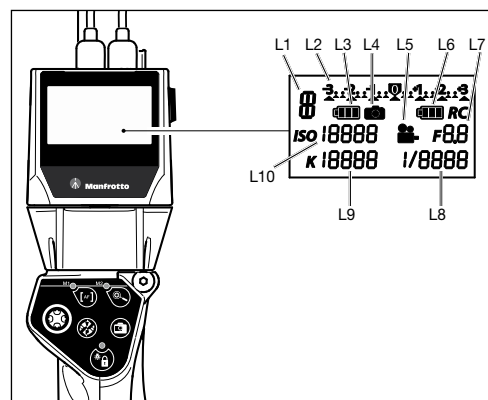

LCD SCREEN

- L1. CAMERA MODE DIAL
- L2. EXPOSURE LEVEL INDICATOR
- L3. CAMERA BATTERY CHECK
- L4. CAMERA MODE
- L5. VIDEO MODE
- L6. REMOTE CONTROL BATTERY CHECK
- L7. APERTURE INDICATOR
- L8. SHUTTER SPEED
- L9. COLOR TEMPERATURE INDICATOR
- L10. ISO INDICATOR

REMOTE CONTROLS FOR CAMCORDERS Manfrotto renews and extends the family of accessories built for the latest cameras (JVC's GY-HM600 and GY-HM650 series, and the eagerly anticipated Blackmagic Cinema Camera) through new restyled remote controls. A new family of renovated products in terms of ergonomics and design, compatible with all protocols and applications. Manfrotto Remote Control units put the most important commands of market-leading video cameras and lenses at your finger-tips.



KEY FEATURES

- Quick-lock fastening clamp with steel core
- Anti-slip soft touch finishing
- Heavy-duty, anti-scratch, dirt-repellent polycarbonate film keyboard
- Wide-rotation (+-50°) Multispeed Zoom/Focus knob
- Direct adjusting of maximum zoom speed
- Functional LEDs

KEY BENEFITS

- Quick fastening on the pan bar
- "Fast zoom" and "Max speed" controls allow for quick camerasetup
- Wide and smooth zoom control



12 to 23mm / 0,47" to 0,90" round tube/pipe/bar grippable diameter.



Anti-scratch. Dirt-repellent keyboard.



Zoom / Focus knob.



Quick lock



Zoom Speed limit.



Remote Control can be set-up for LANC (Canon/Sony) and Panasonic cameras.

MVR901ECPL CLAMP-ON REMOTE CONTROL **SC P**

Remote control can be set-up for LANC (Canon/Sony) and Panasonic cameras.

- LANC/Panasonic switch
- Stand-by push button (for LANC only)
- REC/STOP push button
- Multi-speed Zoom knob
- REC/STOP LED (for LANC only)
- Zoom direction knob (by software)



MVR901ECLA LANC REMOTE CONTROL **SC**

Advanced remote control for LANC (Canon/Sony) cameras.

- Stand-by push button
- REC/STOP push button
- Zoom and focus direction knob (by software)
- Multi-speed Zoom and Focus knob
- Max-speed zoom potentiometer
- Rec, Zoom and Focus indicator LED's



MVR901ECEX CLAMP-ON REMOTE CONTROL **EX**

Remote control compatible with Sony PMW EX-family cameras.

- REC/STOP push button
- Zoom direction switch
- Multi-speed Zoom knob
- Max-speed Zoom potentiometer
- RET push button (plays back latest 5s)
- Power indicator LED
- Fast zoom push buttons



521PFI FOCUS AND IRIS REMOTE CONTROL **P**

Remote control for setting Focus and Iris on Panasonic cameras.

- Focus knob
- IRIS knob
- Focus and IRIS Auto/Man switches
- Focus and IRIS direction switches
- Focus limits setup



521CFI ZOOM REMOTE CONTROL **ENG**

Remote control for ENG lens (Canon and Fujinon).

- REC/STOP push button
- Zoom direction switch
- Multi-speed Zoom knob
- Max-speed Zoom potentiometer
- RET push button
- REC indicator LED



Key to symbols

- SC** SONY - CANON
- EX** SONY EX
- P** PANASONIC
- ENG** ENG LENS

REMOTE CONTROLS FOR PAN BARS The Pan Bar version of the RC family has been totally restyled by focusing on their ergonomics, setup and new functionalities of the cameras. Thanks to innovative solutions, refined layouts and a thorough study of materials, all new RC models perfectly balance lightness, sturdiness and fluidity as required by professionals. In order to pursue innovative and eco-friendly solutions, PVC-free handle have been introduced for the first time.

KEY FEATURES

- Aluminum fixing rosette, compatible with Manfrotto video heads
- Accessory clamp for attaching to any pan bar
- Anti-slip softtouch finishing
- PVC-free grip
- Heavy-duty, anti-scratch, dirt-repellent polycarbonate film keyboard
- Wide-rotation (+-40°) multi-speed Zoom/Focus knob
- Direct adjusting of maximum zoom speed

KEY BENEFITS

- Wide range of fastening solutions
- Wider Zoom/Focus knob, for better control
- A thorough set of controls and precision mechanics for a smooth and customizable zooming and focusing
- IRIS remote control for enabled cameras



Direct coupling with Manfrotto heads for maximum rotation control.



Direct adjusting of maximum zoom speed.



Rotatable pan bar.



PVC-free "high-textured" handle.



Wide and ergonomic Zoom/Focus knob.

MVR901EPLA PAN BAR REMOTE CONTROL

SC

Pan-bar remote control for cameras with LANC (Sony and Canon).

- REC/STOP
- Push Button
- Max-speed Zoom potentiometer
- Stand-by push button
- RET push buttons (play back latest 5s)
- IRIS Push Button
- REC, Zoom and Focus indicator LED's
- Zoom and focus direction knob (by software)
- Multi-speed Zoom and Focus knob
- Focus/Zoom switch
- Auto/Man Focus switch



MVR901EPEX PAN BAR REMOTE CONTROL

EX

Remote control with standard pan bar for Sony PMW EX-family cameras

- REC/STOP push button
- Zoom direction switch
- Multi-speed Zoom knob
- Max-speed Zoom potentiometer
- RET push button (plays back latest 5s)
- Power indicator LED
- Fast zoom push buttons



522P FOCUS AND IRIS REMOTE CONTROL

P

Remote control with standard pan bar for Panasonic cameras.

- REC/STOP push button
- Multi-speed Zoom knob
- Preset Zoom speeds (with extra battery)



524CFI REMOTE CONTROL

ENG

Remote control with standard pan bar for ENG lens (Canon and Fujinon).

- REC/STOP push button
- Zoom direction switch
- Multi-speed Zoom knob
- Max speed Zoom potentiometer
- RET push button (plays back latest 5)
- REC indicator LED



522AV ADAPTOR CABLE FOR AV-R SONY CONNECTOR

Made for video cameras with the AV-R plug, the 522AV converts the possibility to connect to these type of cameras all the Manfrotto remote controls.



524 ADAPT ENG LENS ADAPTER CABLE

This optional 10cm (3.9in) adapter cable allows you to convert the 8-pin 524CFI and 521CFI Remote Control cable to a 12-pin configuration found on some Fujinon ENG lenses.



522SCA REMOTE CONTROL CABLE STANDARD

2.5mm male/male jack coiled cord cable measuring 140cm (55in) when extended, supplied as standard with all the units.



523RC RAIN COVER

Waterproof cover for Manfrotto remote control supplied with a crystal clear vinyl panel allows the viewing of the remote control button during the shooting session. The cover slips quickly over the remote pan bar to protect it from rain or sudden showers.



MVR901APCL PAN BAR CLAMP ADAPTOR

Manfrotto attachment, casting teeth.
Clamp Range: round tube 19 to 25mm.
Quick-fastening system.





ALTERNATIVE SUPPORTS

Manfrotto hydrostatic arms, clamps and other alternative supports and accessories are fundamental video support “tools” needed to create the perfect supporting solution in every situation.



814-1 MINI HYDROSTATIC ARM

A small and incredibly powerful arm (max load is 3,5kg - 7.7lb) that spans 13cm (0.4in). The pivoting pins are 1/4" and 3/8" male threaded with one adjustable platform ring offering a larger footprint for the equipment being supported by the arm.



3,5kg
7.7lb



0,2kg
0.5lb



819-1 SMALL HYDROSTATIC ARM

This arm spans 18cm (7.1in) and can support up to 2,2kg (4.8lb). The 819-1 is the ideal companion for attaching a video monitor to a camera or using as a flag support. The pivoting pins are 1/4" and 3/8" male threaded with one adjustable platform ring offering a larger footprint for the equipment being supported by the arm.



2,2kg
4.9lb



0,2kg
0.5lb



823 MEDIUM HYDROSTATIC ARM

This is the first arm that features 5/8" male and 3/8"+1/4" female thread pins to support larger and heavier items. One of the two pins is hex shaped to marry perfectly with our Super Clamp. With a total length of 23,5cm (9.3in), the 823 is ideal to position LCD monitors, lighting fixtures or cameras virtually anywhere.



0,55kg
1.2lb



4kg
8.8lb



244RC VARIABLE FRICTION ARM WITH QUICK RELEASE PLATE

Articulated arm with large locking knob. Variable friction and locking of arm obtained by adjusting the knob. Supplied with quick release camera plate with secondary safety lock based on the 200PL-14 camera plate mechanism. Ideal for mounting a video camera exactly at the angle you need it. Fits any 5/8" female socket, works especially well with Super Clamp 035C.



4kg
8.8lb



1,1kg
2.4lb



200PL-14



143RC MAGIC ARM WITH QUICK RELEASE PLATE

Your extra arm in the studio. One lever locks three pivot points. Supplied with a quick release camera plate with secondary safety lock based on the 200PL-14 system. Ideal for mounting a camcorder exactly at the angle you need it. Fits any 5/8" female sockets, works especially well with Super Clamp 035C.



4kg
8.8lb



1,1kg
2.4lb



200PL-14

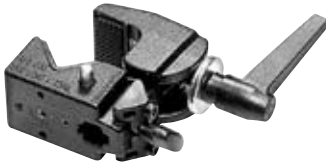

035C SUPER CLAMP

This universal clamp can be securely mounted on any tube from 13 to 45mm (0.5 to 1.8in). Attachment is 5/8" hexagonal socket, plus 1/4" female thread.



15kg
33.1lb



0,5kg
1.1lb



234RC MONOPOD QUICK RELEASE TILT TOP

Tilt head with quick release camera plate system and secondary safety lock.



2,5kg
5.5lb



6cm
2.4in



0,3kg
0.6lb



200PL-14



241FB PUMP CUP WITH FLAT BASE

Suction cup for lightweight video cameras. The 60mm (2.4in) diameter disc with a 3/8" W male thread is built in the pump cup and enables you to mount most of Manfrotto's heads.



0.6kg
1.4lb



037 CAMCORDER MOUNTING STUD

Reversible stud with 3/8" and 1/4" designed for mounting camcorders on Super Clamp 035C.



386BC NANO CLAMP

The new Manfrotto small size clamp. Its reduced size is the most important plus: the Nano Clamp is 4kg (8.8lb) of payload in 110g (2.4lb) of weight and the right size for any pocket.

The Nano Clamp is also a full pack of new technological advances:

- a new patented unexposed thread system
- a new high friction tape which improves the grip
- high performance aluminum
- pull and lock aluminum handle
- unique surface design that was studied on the smallest surface to be able to grip round or flat tube/pole surface.

The clamp comes with a 1/4"-3/8" female thread and 1/4"-3/8" adapter.



4kg
8.8lb



0,1kg
0.2lb



241 PUMP CUP

Suction cup for small equipment.
Diameter: 150mm (5.9in).



1.2kg
2.6lb



MVA500 EASY LINK CONNECTORS

Easy Link 3/8" connector to allow an external monitor or other accessory equipment to be fitted. It allows to support an external monitor or other accessories. Suitable for bridging heads and Sympla plates.



ACCESSORIES

HEAD ACCESSORIES: the Manfrotto head accessory system includes a wide range of products that satisfy all the customer needs in terms of camera attachment and customized pan bar. All the Manfrotto plates are made of aluminum with a travelling distance up to 140mm (5.5in). Also the Manfrotto pan bars are assembled with aluminum tubes with a maximum extension of 58cm (22.8in).



323 RECTANGULAR VIDEO QUICK RELEASE ADAPTER

This quick release adapter gives you the freedom to remove the camera from the head without detaching it from the plate and put it on any other support. Supplied with 1/4" camera screw. Dimensions: 73,7x26,5x67,5mm (2.9x1x2.7in).



577 VIDEO QUICK RELEASE ADAPTER

This quick release adapter gives you the freedom to remove the camera from the head without detaching it from the plate and put it on any other support. Supplied with 1/4" and 3/8" camera screws. Dimensions: 90x23,5x100mm (3.5x0.9x3.9in) - 20mm (0.8in) travel.



357 ADAPTER

This quick release adapter gives you the freedom to remove the camera from the head and put it on any other support. Supplied with 2x1/4" and 2x3/8" camera screw. Dimensions: 140x22x99mm (5.5x0.9x3.9in) - 80mm (3.1in) travel.



200PL-14 VIDEO CAMERA PLATE

This standard plate is supplied with 1/4" camera fixing screw. Dimensions: 53x11,2x42,3mm (2.1x0.4x1.7in).



501PL VIDEO CAMERA PLATE

This standard sliding plate is supplied with 1/4" and 3/8" camera fixing screws. Dimensions: 90x11x50mm (3.5x0.4x2in).



500PLONG VIDEO CAMERA PLATE

Sliding camera plate, suitable for all Bridging Technology™ Manfrotto Video Heads. Originally supplied with the Manfrotto Video Heads MVA500A and MVA500AH. Supplied with 1x1/4", 1x3/8" camera screws and anti-rotation pin. Dimensions: 120x10,7x50mm (4.7x0.4x2in).



501PLONG VIDEO CAMERA PLATE

The long version of the standard plate, that has a laser engraved scale (110mm), features a variable VHS pin position. This can be moved along the length of the plate. Supplied with 2 x 1/4" and 2 x 3/8" camera fixing screws. Dimensions: 140x11x50 mm (5.5x0.4x2in).



504PLONG VIDEO CAMERA PLATE

Sliding camera plate, suitable for all Bridging Technology™ Manfrotto Video Heads. Originally supplied with the Manfrotto Video Heads MVH502A, MVH502AH and 504HD. Supplied with 2x1/4" and 2x3/8" camera screws and anti-rotation pin. Dimensions: 140x10,7x56mm (5.5x0.4x2.2in).



509PLONG VIDEO CAMERA PLATE

Sliding camera plate, suitable for Manfrotto Video Heads. This plate works together with the new ABR (Advanced Balancing Recorder) system, thanks to a special built-in index. Originally supplied with the Manfrotto Video Head 509HD. Supplied with 2x1/4" and 2x3/8" camera screws and anti-rotation pin. Dimensions: 140x10,7x56mm (5.5x0.4x2.2in).



357PLV VIDEO CAMERA PLATE

This standard sliding plate is supplied with 2x1/4" and 2x3/8" camera fixing screws. Dimensions: 140x10,7x56mm (5.5x0.4x2.2in).



357PLONG VIDEO CAMERA PLATE

This long version of the standard plate allows perfect balance for camcorders with unusual weight distribution caused by long telescopic lenses or heavy batteries. Supplied with 2x1/4" and 2x3/8" camera screws. Dimensions: 210x11,1x56mm (8.3x0.4x2.2in).

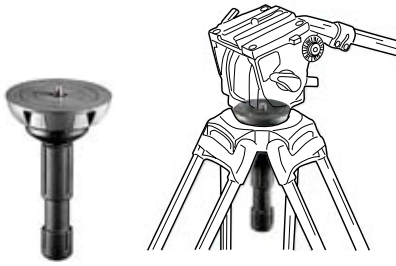

500BALL 100MM HALF BALL

Half ball for leveling video heads on video tripod.
Length 17cm (6.7in). Attachment: 3/8" male thread.



500BALLSH 100MM SHORT HALF BALL

The 500BALLSH comes complete with a short locking handle to mount all Manfrotto flat-base heads to the 529B Hi-Hat.
Length 12,5cm (4.9in). Attachment: 3/8" male thread.

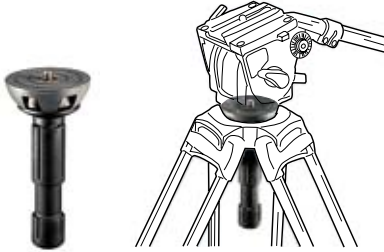

520BALL 75MM HALF BALL

Half ball for leveling video heads on video tripods provided with 75mm bowl.
Length 16cm (6.3in). Attachment: 3/8" male thread.



520BALLSH 75MM SHORT HALF BALL

The 520BALLSH comes complete with a short locking handle to mount all Manfrotto flat-base heads to any 75mm bowl tripod including the 529B Hi-Hat (with optional adapter 319).
Length 11,5cm (4.5in). Attachment: 3/8" male thread.



319 100MM TO 75MM ADAPTER

Converts all Manfrotto 100mm bowl tripods into a 75mm bowl.

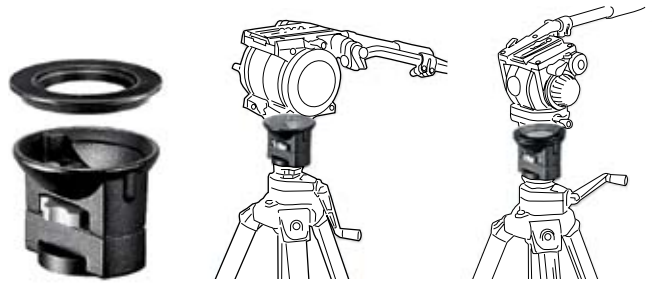

325N VIDEO HEAD BOWL ADAPTER

Adapter system to connect a 75 or 100mm half bowl video head to a flat base tripod.



MVA060T 75MM TO 60MM ADAPTER

Converts all Manfrotto 75mm bowl tripods into a 60mm bowl.



500HLV PAN BAR

Pan bar for the MVH500A and MVH500AH fluid video heads.
Length 34cm (13.4in).



502HLV PAN BAR

Pan bar for the MVH502A and MVH502AH fluid video heads.
Length 35,5cm (14in).



509HLV PAN BAR

Pan bar for the 504HD and 509HD fluid video heads.
Max length 60,5cm (23.8in) - Min length 37,5cm (14.7in) - Extension 23cm (9in).

TRIPOD ACCESSORIES: in order to customize your tripod for every different environment, the Manfrotto tripod accessories range includes a complete set of different dollies, spreaders and reversible spiked feet.



114 VIDEO DOLLY

Heavy duty, super sturdy, designed for use with large video tripods; individually braked wheels with cable guards. Folds for transporting. Includes 3/8" attachment which allows you to attach a head for low angle shooting.



60kg
13.3lb



8kg
17.6lb



112cm
44.1in



114MV PORTABLE DOLLY

Same as 114 dolly with ability to accept spiked tip tripods. Includes 3/8" attachment which allows you to attach a head for low angle shooting.



60kg
13.3lb



6,2kg
13.7lb



112cm
44.1in



181B FOLDING AUTODOLLY

Single lever braking system controls all three 80mm wheels. It folds legs for transporting and storage. Includes 3/8" attachment which allows you to attach a head for low angle shooting.



25kg
55.1lb



4,5kg
9.9lb



127cm
50in



127 VIDEO DOLLY

Designed for light and medium weight tripods. The 76mm wheels have a sure-lock feature that raises the wheels free off the ground so that the dolly then rests on extended feet. Includes 3/8" attachment which allows you to attach a head for low angle shooting.



10kg
22lb



2,4kg
5.3lb



110cm
43.3in



127VS BASIC DOLLY

Everything that the 127 has with the ability for a variable spread for the legs. Suitable for standard and spiked feet. Includes 3/8" attachment which allows you to attach a head for low angle shooting.



10kg
22lb



3,4kg
7.5lb



78-114cm
30.7-44.9in

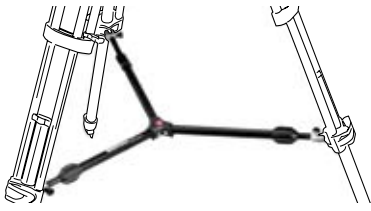

537SPRB MID LEVEL SPREADER

The new telescopic mid-level spreader allows you to set the proper leg angle and resulting tripod footprint.



165 TRIPOD SPREADER

Universal tripod spreader with variable diameter width controls from 80 to 130cm (31.5 to 51.2in).



0.6kg
1.4lb



80-130cm
31.5-51.2in



165MV TRIPOD SPREADER FOR SPIKED FEET

Universal tripod spreader with variable diameter width controls from 80mm to 130mm (31.5 to 51.2in). It accepts spiked tip tripod.



0.6kg
1.4lb



80-130cm
31.5-51.2in



204SPK3 REVERSIBLE SPIKED FOOT

Reversible rubber/metal spiked feet (set of 3) supplied with a dedicated fixing tool. The spike is made of a special hard anodized aluminum alloy extremely resistant to corrosion. See chart below for tripod compatibility.



204SCK3 SUCTION CUP/RETRACTABLE SPIKED FEET

A rubber suction cup feet (set of 3) with retractable stainless steel spike. The suction cup increases the footprint of the foot by almost 20 times, giving much greater stability when needed. See chart below for tripod compatibility.



565 SPIKED FOOT SHOES

Set of 3. See chart below for tripod compatibility.

	DOLLY					MID SPREADER	SPREADER		REVERSIBLE FEET	SUCTION CUP FEET	
TRIPOD MODELS	114	114MV	181B	127V	127VS	537SPRB	165	165MV	204SPK3	204SCK3	565
545B		X	X					X			
545GB		X	X			X					X
546B		X	X					X			
546GB		X	X			X					X
MVT502AM											
535	X			X	X						
536	X			X	X						
755CX3									X	X	
755XB									X	X	
528XB	X			X	X		X				
117B	X			X	X		X				

PLEASE NOTE: this chart only shows technical compatibility. When assembling the products always consider the maximum load of the component with the lowest loading capacity.



492LCD LCD MINI BALL HEAD

The 492LCD mini ball head is a swivel mounting accessory that can be attached to the bottom of LCD or TFT monitors so you can mount the monitor to the top of the camera by using the "hot shoe" located on the top of most camcorders.



2kg
4.4lb



6,4cm
2.5in



0,15kg
0.3lb



529B HI-HAT

529B Hi-Hat enables you to get shots from the dog's perspective. The 529B has a 100mm half-bowl, adjustable leg angles to mount the camera in the tightest or lowest of locations and thanks to the built-in spreader you can simply use the 529B on any even surface. The feet are rubber-padded to protect delicate surfaces and have a hole so that the 529B can be screwed to a ladder, apple-box or a sheet of wood.

Recommended heads:

- 526
- 509HD
- 504HD (with 319 adapter)
- MVH502A (with 319 adapter), MVH502AH (with 500BALLSH half ball)



20kg
44.1lb



14,5cm
5.7in



19,5cm
7.7in



20,5cm
8.1in



2,7kg
6lb



BAGS AND STRAPS

Not only bags!! But I would leave it off and start with Manfrotto video product range is completed with a range of soft goods that allows an easy transportation and storage. A complete family of padded bags developed with multihandles and internal pockets, six different dimensions from the smallest MBAG70N up to the largest MBAG120PN. Different typologies of straps are available, presenting different design and materials for alternative carrying solutions.



Easy access even with the bigger video tripods.



Rebated zippers.



Thermoformed padding with the new Manfrotto logo.



Attention to details: small injected Manfrotto logo on the handles.



Comfortable carrying handle.

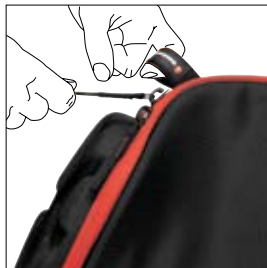

Rubberized Manfrotto loop, helps when using the zips. This feature is used on all the new Manfrotto bags, functional and iconic.



Inner pocket for tripod accessory storage.



MBAG120PN

MBAG100PN

MBAG90PN

MBAG80PN

MBAG80N

MBAG70N

MBAG120PN 120CM PADDED TRIPOD BAG

The largest bag in the range, the MBAG120PN is padded to protect your equipment and has the following features:

- Asymmetric tapered shape allows you to store the tripod with the head attached.
Tripod legs fit comfortably in the narrower end and extra space is allowed for the larger volume of the head at the wider end. Diameter 23cm (9.1in).
- Zipper extends down the length of the bag, but also fully opens the top end of the bag.
- Thermoform padding holds the tripod in place in the bag and protects it, especially the head, during transport.
- Inner pocket holds accessories (such as video head pan bars).
- Innovative design and style; ballistic nylon, zips and other materials used are of top quality.
- Can be hand-carried horizontally by the side handle, vertically by the end handle (also useful for storage), or shoulder-carried using the included strap.

MBAG100PN 100CM PADDED TRIPOD BAG

Same design of MBAG120PN 20cm smaller and without the double positioning carrying handle.
Diameter 23cm (9.1in).

MBAG90PN 90CM PADDED TRIPOD BAG

Same design of MBAG120PN 30cm smaller and without the double positioning carrying handle.
Diameter 23cm (9.1in).

MBAG80PN 80CM PADDED TRIPOD BAG

Same design of MBAG120PN 40mm smaller and without the side handle or inner accessory pocket. The MBAG80PN is also narrower than the other padded bags. The narrow end measures 13cm (5.1in) diameter, the wide end measures 15cm (5.9in).

MBAG80N 80CM UNPADDED TRIPOD BAG

The MBAG80N is an unpadded tripod bag.

- Slightly tapered to provide a better fit for your tripod with attached head. The wider end of the bag accommodates the head without requiring all levers to be removed.
- Zipper extends down the length of the bag, but also fully opens the top end of the bag.
- Logo end cap is padded to offer protection to the tripod head, the rest of the bag is unpadded.
- Shoulder strap included (the MBAG80N doesn't have either end or side handle).
- Innovative design and style; ballistic nylon, zips and other materials used are of top quality. Diameter 13cm (5.1in).

MBAG70N 70CM UNPADDED TRIPOD BAG

Same design of MBAG80N 10cm smaller.



401N QUICK ACTION STRAP

A quick and easy accessory for carrying your tripod when walking, hiking, cycling or just getting from shoot to shoot. Use the shorter straps to fasten the padded 401N to one of the legs of your tripod, bind the remaining legs together using the longer adjustable quick release straps, sliding the tripod over your shoulder and you're ready to go, with your hands free to grab those vital last minute items. The padding helps hold the tripod in place and protects your back from bruises and chaffing. The 401N even stays attached to your tripod when shooting (all you need to do is release the longer quick release straps so you can maneuver and position all three legs), so you're always ready to capture the images you want, but also always ready to move off again to the next location.



Straps can be removed and custom-positioned to better match the size of your tripod.

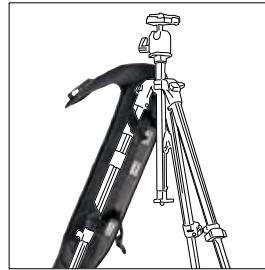

The strap stays attached to your tripod when shooting.

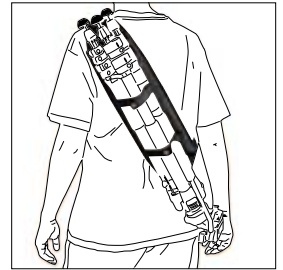

MSTRAP-1 TRIPOD SHOULDER STRAP

The MSTRAP-1 allows you to carry the tripod when attached to the ring positioned right under the tripod collar.



MSTRAP-2 TRIPOD HANDLE STRAP

The MSTRAP-2 is a convenient and smart way to carry a video tripod plus a head. The ergonomics of this strap allows to carry easily the products. Safe grip thanks to the rubber coated adjustable velcro. Easy to mount, safely hooked to the upper casting of the tripod. Well balanced, also with heavy duty video heads, thanks to the ergonomics of the handle.



102 LONG STRAP

The 102 strap is a basic but convenient way to carry your system. It has a spring clip that fastens quickly to the steel ring at the shoulder of the tripod, and a closed loop that goes around the feet of the tripod and tightens to grip them securely. Features an adapter for compatibility with all Manfrotto tripods and rubberized fabric for comfort and to avoid the tripod slipping on your shoulder.



















402 SHORT STRAP

The 402 is a simple loop strap, with a single spring clip that attaches quickly to the steel ring at the shoulder of your tripod. Features an adapter for compatibility with all Manfrotto tripods. Strap is in grey rubberized fabric for comfort and to avoid the tripod slipping on your shoulder.

Key to symbols

Tripod symbols

-  Twin leg
-  Single leg
-  Flat base
-  60mm + 75mm bowl
-  75mm + 100mm bowl
-  75mm bowl
-  100mm bowl
-  60mm bowl + half ball included
-  75mm bowl + half ball included
-  100mm bowl + half ball included
-  Flat base with 3/8" screw + extendible (geared) center column
-  Leveling flat base with 3/8" screw + extendible center column
-  Aluminum
-  Carbon Fiber
-  1 stage
-  2 stages
-  3 stages

Closed length 

Minimum height 

Maximum height 

Maximum height with extended center column 

Footprint diameter 

Counterbalanced weight
Suggested maximum weight that the product can properly balance. It indicates the working (dynamic) payload, without the help of tilt brake 

Safety payload
Maximum weight that the product can carry/support in static condition. Ability of the head to support, move and lock (with pan&tilt brakes) a certain weight 

Weight 

Head height 

Plate supplied with the head 

Head symbols

 C.O.G.

C.O.G.: Center Of Gravity is the weighted average location of all the mass in a body. Depending on the dimensions of the camera, the distance from the plate to the C.O.G. will be longer or shorter. Lightweight/compact cameras and HDSLRs will have a shorter distance from the plate to the C.O.G. and bigger cameras will have a longer distance from plate to C.O.G. Video head performance is measured with different distances of COG according to the load capacity of the head. We use two standard C.O.G. measurements:
 - @ 55mm for Ø60-75mm half bowl heads 701HDV, MVH500A(H), 501HDV, MVH502A(H), 504HD
 - @ 125mm for Ø100mm half bowl heads (509HD, 526)

 CBS
COUNTER BALANCE SYSTEM

CBS is our Counterbalance System; a fundamental part of what makes our video heads such useful video tools. The principal function of CBS is to cancel out the slow falling effect seen in video footage when the videocamera's own weight causes it to tilt forward or backward on an unbalanced video head. CBS ensures that the cameraman need only apply minimal effort to the head's pan bar to move the camera precisely and smoothly.

 FDS
FLUID DRAG SYSTEM

FDS is a friction system used across the Manfrotto video head and monopod ranges, based on specially developed cartridges that make movements fluid and help stop unwanted vibrations (such as those from the video operator's own hand) being transmitted. Our range uses two types of FDS: fixed and variable. Variable FDS allows you to regulate and control the level of friction applied based on the type and style of video you're shooting, on the weight of your camera equipment and on climatic conditions and temperature.

 ABR
ADVANCED ANALYTIC RECORDER

Our patented electronic system allows you to record the position at which a particular equipment set-up is perfectly balanced, and then recall that position easily any time you need to use the same equipment again.



INDEX

Art. N°	Description	Page
035C	SUPER CLAMP	55
037	CAMCORDER MOUNTING STUD	55
102	LONG STRAP	64
114	VIDEO DOLLY	58
114MV	PORTABLE DOLLY	58
117B	PRO VIDEO TRIPOD	27
127	VIDEO DOLLY	59
127VS	BASIC DOLLY	59
143RC	MAGIC ARM WITH QUICK RELEASE PLATE	54
165	TRIPOD SPREADER	60
165MV	TRIPOD SPREADER FOR SPIKED FEET	60
181B	FOLDING AUTODOLLY	59
200PL-14	VIDEO CAMERA PLATE	56
204SCK3	SUCTION CUP/RETRACTABLE SPIKED FEET	60
204SPK3	REVERSIBLE SPIKED FEET	60
234RC	MONOPOD QUICK RELEASE TILT TOP	55
241	PUMP CUP	55
241FB	PUMP CUP WITH FLAT BASE	55
244RC	VARIABLE FRICTION ARM WITH QUICK RELEASE PLATE	54
319	100MM TO 75MM ADAPTER	57
323	RECTANGULAR VIDEO QUICK RELEASE ADAPTER	56
325N	VIDEO HEAD BOWL ADAPTER	57
357	ADAPTER	56
357PLONG	VIDEO CAMERA PLATE	56
357PLV	VIDEO CAMERA PLATE	56
386BC	NANO CLAMP	55
401N	QUICK ACTION STRAP	64
402	SHORT STRAP	64
492LCD	LCD MINI BALL HEAD	61
500BALL	100MM HALF BALL	57
500BALLSH	100MM SHORT HALF BALL	57
500HLV	PAN BAR	57
500PLONG	VIDEO CAMERA PLATE	56
501PL	VIDEO CAMERA PLATE	56
501PLONG	VIDEO CAMERA PLATE	56
502HLV	PAN BAR	56
504PLONG	VIDEO CAMERA PLATE	56
504HD	FLUID VIDEO HEAD - 75MM HALF BALL	12
504HD, 535K	VIDEO SYSTEM	13
504HD, 536K	VIDEO SYSTEM	13
504HD, 546BK	VIDEO SYSTEM	13
504HD, 546GBK	VIDEO SYSTEM	13
509HD	PRO FLUID VIDEO HEAD - 100MM HALF BALL	14
509HD, 536K	VIDEO SYSTEM	15
509HD, 545BK	VIDEO SYSTEM	15
509HD, 545GBK	VIDEO SYSTEM	15
509HLV	PAN BAR	57
509PLONG	VIDEO CAMERA PLATE	56
520BALL	75MM HALF BALL	57
520BALLSH	75MM SHORT HALF BALL	57
521CFI	ZOOM REMOTE CONTROL FOR ENG LENSES	51
521PFI	FOCUS/IRIS REMOTE CONTROL FOR PANASONIC	51
522AV	ADAPTOR CABLE FOR AV-R SONY CONNECTOR	53
522P	FOCUS/IRIS REMOTE CONTROL FOR PANASONIC	53
522SCA	REMOTE CONTROL CABLE STANDARD	53
523RC	RAIN COVER FOR REMOTE CONTROL	53
524ADAPT	ENG LENS ADAPTER CABLE	53
524CFI	REMOTE CONTROL FOR ENG LENSES	53
526	PRO FLUID VIDEO HEAD - 100MM HALF BALL	16
526, 528XBK	VIDEO SYSTEM	17
526, 536K	VIDEO SYSTEM	17
526, 545BK	VIDEO SYSTEM	17
526, 545GBK	VIDEO SYSTEM	17
528XB	PRO HEAVY VIDEO TRIPOD	27
529B	HI-HAT	61
537SPRB	MID LEVEL SPREADER	60
535	MPRO CARBON FIBER 2-STAGE VIDEO TRIPOD	21
536	MPRO CARBON FIBER 3-STAGE VIDEO TRIPOD	21
545B	PRO HEAVY-DUTY VIDEO TRIPOD	25
545GB	PRO HEAVY-DUTY VIDEO TRIPOD	25
546B	PRO VIDEO TRIPOD	26
546GB	PRO VIDEO TRIPOD	26

Art. N°	Description	Page
560B-1	FLUID VIDEO MONOPOD	29
562B-1	FLUID VIDEO MONOPOD	29
565	SPIKED FOOT SHOES	60
577	VIDEO QUICK RELEASE ADAPTER	56
595B	FIG RIG	45
595CLA	FIG RIG CLAMP	45
755CX3	MDEVE MAGFIBER VIDEO TRIPOD	19
755XB	MDEVE ALUMINUM VIDEO TRIPOD	19
814-1	MINI HYDROSTATIC ARM	54
819-1	SMALL HYDROSTATIC ARM	54
823	MEDIUM HYDROSTATIC ARM	54
MBAG100PN	100CM PADDED TRIPOD BAG	63
MBAG120PN	120CM PADDED TRIPOD BAG	63
MBAG70N	70CM UNPADDED TRIPOD BAG	63
MBAG80N	80CM UNPADDED TRIPOD BAG	63
MBAG80PN	80CM PADDED TRIPOD BAG	63
MBAG90PN	90CM PADDED TRIPOD BAG	63
MICC1	MICROPHONE CLIP	45
MICC2	MICROPHONE SPRING CLIP	45
MICC4	UNIVERSAL SHOCK MOUNT MICROPHONE HOLDER	45
MSTRAP-1	TRIPOD SHOULDER STRAP	64
MSTRAP-2	TRIPOD HANDLE STRAP	64
MVA060T	75MM TO 60MM ADAPTER	57
MVA500	EASY LINK CONNECTORS	42-55
MVH500A	FLUID VIDEO HEAD - 60MM HALF BALL	8
MVH500AH	FLUID VIDEO HEAD - FLAT BASE	8
MVA511W-1	PADDED SHOULDER MOUNT	39
MVA511WK-1	SHOULDER MOUNTED RIG	33
MVA511P	PADDING FOR SHOULDER MOUNT	43
MVA512W	FLEXIBLE MATTEBOX	38
MVA512WK-1	FLEXIBLE MATTEBOX SYSTEM	34
MVA513WK-1	LONG LENS SUPPORT SYSTEM	35
MVA513W	FIXED PLATE	36
MVA514W	LENS SUPPORT	41
MVA515W	VARIABLE PLATE	36
MVA516W	BODY SUPPORT	41
MVA517W	UNIVERSAL MOUNT	41
MVA518EXT	EXTENSIONS FOR HANDLES	43
MVA518W	ADJUSTABLE HANDLES	37
MVA519W	160MM H-OFFSET	39
MVA519S	80MM H-OFFSET	39
MVA520	CONNECTORS FOR RODS	42
MVA520W-1	RODS - 300MM	37
MVA521	EXTENSION TUBES FOR COUNTERWEIGHT	42
MVA521W	COUNTERWEIGHT	39
MVA521L	LIGHT COUNTERWEIGHT	39
MVA522	FIG RIG - SYMPLA ADAPTOR	40-45
MVA522W	FIG RIG - SYMPLA VERSION	40
MVA523W-1	RODS - 150MM	37
MVA524W	V-OFFSET	39
MVA525W	RC2 MOUNT	36
MVA525WK	LIGHTWEIGHT SHOULDER MOUNTED RIG	32
MVH500AH, 755CX3K	VIDEO SYSTEM	9
MVH500AH, 755XBK	VIDEO SYSTEM	9
MVH502A	FLUID VIDEO HEAD - 75MM HALF BALL	10
MVH502A, 546BK-1	VIDEO SYSTEM	11
MVH502A, 546GB-1	VIDEO SYSTEM	11
MVH502AH	FLUID VIDEO HEAD - FLAT BASE	10
MVK500AM	VIDEO SYSTEM	9
MVK502AM-1	VIDEO SYSTEM	11
MVK502C-1	VIDEO SYSTEM	11
MVK500C	VIDEO SYSTEM	9
MVM500A	FLUID MONOPOD WITH 500 HEAD	9-28
MVR901APCL	PAN BAR CLAMP ADAPTOR	53
MVR901ECEX	CLAMP-ON REMOTE CONTROL	51
MVR901ECLA	LANC REMOTE CONTROL	51
MVR901ECPL	CLAMP-ON REMOTE CONTROL	51
MVR901EPEX	PAN BAR REMOTE CONTROL	53
MVR901EPLA	PAN BAR REMOTE CONTROL	53
MVR911ECCN	CLAMP-ON HD/SLR REMOTE CONTROL FOR CANON	46
MVR911EJCN	JOYSTICK HD/SLR DELUXE REMOTE CONTROL FOR CANON	48
MVT502AM	TELESCOPIC-TWIN LEG TRIPOD	23

The skills of the world's best photographers and video operators are brought together by Manfrotto in an innovative on-line platform.

Featuring:
Harry De Zitter,
Bill Frakes,
Joe McNally,
Drew Gardner,
Roberto Bigano,
Ami Elsius,
Marc de Tollenaere,
Kristoff Ramon,
David Duchemin,
Milko Marchetti,
Uri Golman,
Adam Barker,
Sébastien Devaud,
Kazuyuki Okajima and many others.



manfrottoschoolofexcellence.com